

1. GENERAL PURPOSE CONTACTORS & STARTERS

Series MS-N

1.1 Conformity to International Standards

Mitsubishi magnetic motor starters and contactors are designed to conform to the relevant IEC recommendations and to the standards of as many countries as possible. Specifically, they conform to the following:

IEC60947-4-1 International
EN60947-4-1 Europe

VDE0660 Germany
NEMA-ICS U.S.A

Table 1.1

Type	Model Name	Europe		North America / UL				China	Marine			
		CE Mark 	TÜV 	Listing 		Recognition 		CCC certification 	U.K. 	France 	Korea 	Japan
				U.S.A. 	Canada 	U.S.A. 	Canada 		Lloyd's Register of Shipping	Bureau Veritas	Korean Register of Shipping	Nippon Kaiji Kyokai
AC Operated Contactor	S-N10(CX)											
	S-N11(CX)/N12(CX)											
	S-N18(CX)											
	S-N20(CX)/N21(CX)											
	S-N25(CX)		⊙ (*2)						⊙	○	○	⊙
	S-N35(CX)											
	S-N28(CX)											
	S-N38(CX)											
	S-N48(CX)											
	S-N50											
	S-N65	⊙		⊙								
	S-N80											
	S-N95											
	S-N125		⊙									
	S-N150									○	○	○
	S-N180											
S-N220												
S-N300												
S-N400												
S-N600												
S-N800		—		☆				★			—	
Overload Relay	TH-N12(CX)KP		○					⊙				
	TH-N18(CX)KP		○ (*2)					—				
	TH-N20(TA)(CX)KP											
	TH-N60(TA)KP	⊙		⊙					○	○	—	—
	TH-N120(TA)KP		○						⊙			
	TH-N220RHKP/HZKP											
TH-N400RHKP/HZKP												
DC Operated Contactor	SD-N11(CX)/N12(CX)		⊙ (*2)									
	SD-N21(CX)											
	SD-N35(CX)											
	SD-N50											
	SD-N65											
	SD-N80			⊙								
	SD-N95	⊙										
	SD-N125		⊙						○	○	—	⊙
	SD-N150											
	SD-N220											
	SD-N300											
	SD-N400											
SD-N600												
SD-N800		—		—	—	—	—	★				
AC Operated Contactor Relay	SR-N4(CX)	⊙	● (*2)	⊙	⊙	⊙ (UL Mark)	⊙ (UL Mark)	⊙	○	○	—	—
DC Operated Contactor Relay	SRD-N4(CX)	⊙	● (*2)	⊙	⊙	⊙ (UL Mark)	⊙ (UL Mark)	⊙	○	○	—	—
Auxiliary Contact Block	UN-AX2(CX)											
	UN-AX4(CX)											
	UN-AX11(CX)	⊙	○ (*2)	⊙	⊙	⊙ (UL Mark)	⊙ (UL Mark)	★	○	○	—	—
	UN-AX80											
	UN-AX150		○	—	—	○	—					

Notes: 1. ⊙ : CE Mark (Manufacturer's Declaration) == Standard model applicable, marking on the product.

UL, TÜV, CCC == Standard model applicable, marking on the product.

NK == Standard model applicable, Certificate No. on the product.

● : Standard model applicable, no marking on the product. If marking required, order model name followed by suffix "DZ".

○ : Standard model applicable, no marking on the product.

☆ : Special model applicable, marking on the product. Order model name followed by suffix "UL".

★ : China export applicable, no marking on the product. Ensure to add "CN" after the model name when placing an order.

— : Not applicable to the Standard or not approved.

2. Finger protection type is certified according to DIN VDE 0106 part 100. For finger protection type, order model name followed by suffix "CX".

3. For each certificate conditions, see next three pages.

1.1.1 List of CE Marked Type



Table 1.1.1

Standard Contactors Non-reversing	A.C. operated	S-N10, S-N11, S-N12, S-N18, S-N20, S-N21, S-N25, S-N28, S-N35, S-N38, S-N48, S-N50, S-N65, S-N80, S-N95, S-N125, S-N150, S-N180, S-N220, S-N300, S-N400, S-N600, S-N800
	D.C. operated	SD-N11, SD-N12, SD-N21, SD-N35, SD-N50, SD-N65, SD-N80, SD-N95, SD-N125, SD-N150, SD-N220, SD-N300, SD-N400, SD-N600, SD-N800
Standard Contactors Reversing	A.C. operated	S-2XN10, S-2XN11, S-2XN20, S-2XN21, S-2XN25, S-2XN35, S-2XN50, S-2XN65, S-2XN80, S-2XN95, S-2XN125, S-2XN150, S-2XN180, S-2XN220, S-2XN300, S-2XN400, S-2XN600, S-2XN800
	D.C. operated	SD-2XN11, SD-2XN21, SD-2XN35, SD-2XN50, SD-2XN65, SD-2XN80, SD-2XN95, SD-2XN125, SD-2XN150, SD-2XN220, SD-2XN300, SD-2XN400, SD-2XN600, SD-2XN800
Additional Auxiliary Contact Blocks		UN-AX2, UN-AX4, UN-AX11, UN-AX80, UN-AX150, UQ-AX2(KR)
Mechanical Interlocks ³		UN-ML11, UN-ML21, UN-ML80, UN-ML150, UN-ML220
Thermal Overload Relays		TH-N12KP, TH-N18KP, TH-N20KP, TH-N20TAKP, TH-N60KP, TH-N60TAKP, TH-N120KP, TH-N120TAKP, TH-N220RHKP, TH-N220HZKP, TH-N400RHKP, TH-N400HZKP, TH-N600KP
Contactor Relays	A.C. operated	SR-N4
	D.C. operated	SRD-N4
D.C. Interface Contactors	Non-reversing	SD-Q11, SD-Q12, SD-Q19
	Reversing	SD-QR11, SD-QR12, SD-QR19
Solid state Contactors (for motor/heater load)		US-N5SS(TE), US-N8SS(TE), US-N20(TE), US-N30(TE), US-N40(TE), US-N50(TE), US-N70NS(TE), US-N80NS(TE), US-NH70NS(TE), US-NH80NS(TE), US-N20(TE)CX, US-N30(TE)CX, US-N40(TE)CX, US-N20(TE)RM
Solid state Contactors (for heater load)		US-H20(DD), US-H30(DD), US-H40(DD), US-H50(DD), US-H20(DD)RM, US-H30(DD)RM

Notes: 1. Listed types are representatives and contains standard models.

2. Applicable product standards

Contactors

Thermal overload relays

Aux. contact blocks

Mechanical interlocks

3. For mechanical interlocks, no marking on the product. Mechanical interlocks are applicable when used in reversing contactors.

4. Necessary to connect a varistor etc., in order to provide compliance for CE marking for the US-N5/N8SS(TE) and US-N(H) 70N(H) 80NS(TE) type.

Solid state Contactors : EN60947-4-2, EN60947-4-3

(for motor/heater load)

Solid state Contactors : EN60947-4-3

(for heater load)

1.1.2 TÜV Certified Type

Contactor



TÜV Rheinland

Table 1.1.2 (1)

Model Name	Applicable standard	Certificate No.	Mirror contact ⁵	
			Internal auxiliary NC contact	Auxiliary contact block Auxiliary NC contact
S-N10(CX)(SA) S-N11(CX)(SA) S-N12(CX)(SA)	EN60947-4-1	R9551340	○	○ (UN-AX2(CX), UN-AX4(CX))
S-N20(CX)(SA) S-N21(CX)(SA)	EN60947-4-1	R9551336		
S-N25(CX)(SA) S-N35(CX)(SA)	EN60947-4-1	R9651190		
S-N18(CX)(SA) S-N28(CX)(SA) S-N38(CX)(SA) S-N48(CX)(SA)	EN60947-4-1	R9651189	—	—
S-N50/S-N65	EN60947-4-1	R9851170	○	○ (UN-AX2(CX), UN-AX4(CX))
S-N80/S-N95	EN60947-4-1	R9851138	○	—
S-N125	EN60947-4-1	R9851169	○	—
S-N150	EN60947-4-1	R9851167	○	○ (UN-AX150)
S-N180/S-N220	EN60947-4-1	R9851164	○	○ (UN-AX150)
S-N300/S-N400	EN60947-4-1	R9851171	○	○ (UN-AX150)
SD-N11(CX)(SA) SD-N12(CX)(SA) SD-N21(CX)(SA) SD-N35(CX)(SA)	EN60947-4-1	R9551340 R9551336 R9651190	○	○ (UN-AX2(CX), UN-AX4(CX))
SD-N50/SD-N65	EN60947-4-1	R9851170	○	—
SD-N80/SD-N95	EN60947-4-1	R9851138	○	—
SD-N125	EN60947-4-1	R9851169	○	—
SD-N150	EN60947-4-1	R9851167	○	○ (UN-AX150)
SD-N220	EN60947-4-1	R9851164	○	○ (UN-AX150)
SD-N300/SD-N400	EN60947-4-1	R9851171	○	○ (UN-AX150)

Notes: 1. Standard models are applicable under following conditions.

Main circuits

(Main contacts)

Auxiliary contacts

Operation coil

: AC-3 rated current at 440V AC max.

and rated continuous current.

: AC-15 rated current at 550V AC max.

and rated continuous current.

: AC coil designation

N10~N12, N18~N48 and SR-N4 ; AC12V~AC440V

N20~N35 ; AC12V~AC380V

N50~N150 ; AC24V~AC500V

N180~N400 ; AC48V~AC500V

DC coil designation DC12V~DC220V

2. For contactors, standard models are with TÜV mark on the product.

For other products, standard models are with no TÜV mark on the product.

3. Finger protection type is certified according to DIN VDE 0106 part 100. For finger protection type, order model name followed by suffix "CX".

4. Models with built-in surge absorber (model name followed by "SA") are also certified.

5. Mirror contact function compliance certification has been obtained from TÜV. This product is suitable for use in a machine tool's interlock circuit. The mirror contact function refers to a function in which the auxiliary NC contact can withstand a 2500V impulse voltage without contacting even if the main contact melts. 3

DC Interface Contactor

Table 1.1.2 (2)

Model Name	Certificate No.	Miller contact ⁵	
		Internal auxiliary NC contact	Auxiliary contact block Auxiliary NC contact
SD-Q11	R2-50004919	○ ⁶	○ (UQ-AX2)
SD-Q12	R2-50004919	○	—
SD-Q19	R2-50004918	○	—
SD-QR11	R2-50004919	—	—
SD-QR12	R2-50004919	—	—
SD-QR19	R2-50004918	—	—

Contacting Relay

Table 1.1.2 (4)

Model Name	Applicable standard	Certificate No.
SR-N4(CX)(SA)	EN60947-5-1	R9551339
SRD-N4(CX)(SA)	EN60947-5-1	R9551339

Thermal Overload Relay

Table 1.1.2 (3)

Model Name	Applicable standard	Registration No.
TH-N12(CX)KP	EN60947-4-1	J9551338
TH-N18(CX)KP	EN60947-4-1	J9551338
TH-N20(TA)(CX)KP	EN60947-4-1	J9551341
TH-N60(TA)KP	EN60947-4-1	J9851140
TH-N120(TA)KP	EN60947-4-1	J9851168
TH-N220RHKP/HZKP	EN60947-4-1	J9851166
TH-N400RHKP/HZKP	EN60947-4-1	J9851172

Auxiliary Contact Block

Table 1.1.2 (5)

Model Name	Applicable standard	Registration No.
UN-AX2(CX)	EN60947-5-1	J9551337
UN-AX4(CX)		
UN-AX11(CX)		
UN-AX80	EN60947-5-1	R9851225
UN-AX150		

Notes: 1. Standard models are applicable under following conditions.

- Main circuits (Main contacts) : AC-3 rated current at 440V AC max. and rated continuous current.
 Auxiliary contacts : AC-15 rated current at 550V AC max. (SD-Q(R)11~Q(R)19 : 440V AC max.) and rated continuous current.
 Operation coil : AC coil designation
 SR-N4 ; AC12V~AC440V
 DC coil designation DC12V~DC220V (SD-Q(R)11~Q(R)19 : DC12V~DC24V)

2. For contactors, standard models are with TÜV mark on the product.
 For other products, standard models are with no TÜV mark on the product.
 For contactor relays, order model name followed by suffix "DZ" if TÜV mark on the product is required.
 3. Finger protection type is certified according to DIN VDE 0106 part 100. For finger protection type, order model name followed by suffix "CX".
 4. Models with built-in surge absorber (model name followed by "SA") are also certified.
 5. Miller contact function compliance certification has been obtained from TÜV. This product is suitable for use in a machine tool's interlock circuit. The miller contact function refers to a function in which the auxiliary NC contact can withstand a 2500V impulse voltage without contacting even if the main contact melts.
 6. If the SD-Q11 with INC is required, it must be so indicated when placing an order.

Solid state contactor (for motor/heater load)

Table 1.1.2 (6)

Model Name	Approval rating (A)						Certificate No.			Applicable standard
	Heater (AC-51)				Motor (AC-53)		Standard	Finger protected	Mounting on 35mm rail	
	AC100-240V		AC200-440V		AC200-240V	AC400-440V				
	40C°	60C°	40C°	60C°	40C°	40C°	US-□	US-□CX	US-□RM	
US-N5SS(TE)	5	3	—	—	3.2	—	R50037627	—	—	
US-N8SS(TE)	8	4.8	—	—	3.2	—				
US-N20(TE)	20	12	20	12	11.1	11.1	R50037628	R50037628	R50037628	
US-N30(TE)	30	18	30	18	17.4	17.4				
US-N40(TE)	40	24	40	24	26	26				
US-N50(TE)	50(45)	30(27)	50(45)	30(27)	26	26				
US-N70NS(TE)	70	42	—	—	48	—				
US-N80NS(TE)	80	48	—	—	48	—	R50037629	—	—	
US-NH70NS(TE)	—	—	65	39	48	48				
US-NH80NS(TE)	—	—	75	45	48	48	R50037630	—	—	

- Notes: 1. The number in the type field indicates the certificate number, and hyphen "-" indicates that there are no compatible models.
 2. The value in the certified rating field in the bracket "()" indicates the rating for US-N50TE.
 3. The frame field "(TE)" indicates 3-pole, 3-element type main circuit.
 4. Standard models are with TÜV mark on the product.

Solid state contactor (for heater load)

Table 1.1.2 (7)

Model Name	Approval rating (A)		Certificate No.			Applicable standard
	Heater (AC-51)		Standard	No cooling fin	Mounting on 35mm rail	
	AC24-480V					
	40C°	60C°	US-□	US-□HZ	US-□RM	
US-H20(DD)	20	12	R50018958	R50018958	R50018958	
US-H30(DD)	30	18				
US-H40(DD)	40	24				
US-H50(DD)	50	30				

- Notes: 1. The number in the type field indicates the certificate number, and hyphen "-" indicates that there are no compatible models.
 2. The frame field "(DD)" indicates 3-pole individual control.
 3. Standard models are with TÜV mark on the product.

1.1.3 UL Approval for U.S.A. and Canada



■ Contactor and Motor Starter

Table 1.1.3 (1)

Mark	c UL US																		c RUS	
	Model Name	S-N10(CX)	S/D-N11(CX) S/D-N12(CX)	S-N18(CX)	S-N20(CX) S/D-N21(CX)	S-N25(CX)	S/D-N35(CX)	S(D)-N50	S(D)-N65	S(D)-N80	S(D)-N95 ²	S(D)-N125 ²	S(D)-N150 ²	S-N180 ²	S(D)-N220 ²	S(D)-N300 ²	S(D)-N400 ²	S-N600 ²		S-N800UR ²
Contactor (open)	Continuous current rating A open	13	20	30	30	35	40	80	95	100	100	125	150	220	220	300	400	680	910	
	Horsepower rating																			
	Single phase	120V HP 240V HP	1/2 1-1/2	1/2 1-1/2	1 3	1 3	2 3	2 5	3 7-1/2	3 10	5 15	7-1/2 15	10 20	15 25	15 30	15 40	— —	— —	— —	— —
	Three phase	208V HP 240V HP 480V HP 600V HP	3 3 5 5	3 3 7-1/2 7-1/2	5 5 10 10	5 5 10 10	7-1/2 7-1/2 15 15	10 10 20 20	15 15 30 30	15 20 40 40	20 25 50 50	25 30 60 60	40 40 75 75	40 50 100 100	60 60 125 125	60 75 150 150	100 100 200 200	125 150 300 300	150 200 400 400	250 300 600 600
Starter (open)	Mark	c UL US																		—
	Model Name	MSO-N10KP(CX)	MSO-N11KP(CX) N12KP(CX)	MSO-N18KP(CX)	MSO-N20KP(CX) N21KP(CX)	MSO-N25KP(CX)	MSO-N35KP(CX)	MSO-N50KP	MSO-N65KP	MSO-N80KP	MSO-N95KP ²	MSO-N125KP ²	MSO-N150KP ²	MSO-N180KP ²	MSO-N220KP ²	MSO-N300KP ²	MSO-N400KP ²	—	—	
	Horsepower rating																			
	Three phase	208V HP 240V HP 480V HP 600V HP	3 3 5 5	3 3 7-1/2 7-1/2	5 5 10 10	5 5 10 10	7-1/2 7-1/2 15 15	10 10 20 20	15 15 30 30	15 20 40 40	20 25 50 50	25 30 60 60	40 40 75 75	40 50 100 100	60 60 125 125	60 75 150 150	100 100 200 200	125 150 300 300	150 200 400 400	— — — —
Max. rating of short circuit protection device																				
Fuse class K5	A	30	30	70	70	100	125	250	250	300	225	350	350	500	500	600 ³	500 ³	800 ⁴	1200 ⁴	
Circuit breaker	A	—	—	—	—	100	125	—	—	300	225	350	350	500	500	600	1000	—	—	

- Notes: 1. UL listed types for S-N600 and S-N800 require suffix letters "UL" (eg. S-N800UL).
 2. Types S-N95 to S-N800 and MSO-N95KP to N400KP with Ilco lugs are also listed as type name with suffix letters "UL" (eg. S-N95UL).
 3. Time delay fuse
 4. Class L fuse

■ Thermal Overload Relay



Table 1.1.3 (2)

Model Name	Heater designation (Rated current [A])	Contactor to be coupled	Auxiliary Contact
TH-N12(CX)KP☆	0.12A(0.1~0.16),0.17(0.14~0.22),0.24A(0.2~0.32),	S-N10 S-N11 S-N12	Rated Code / C600 AC600Vmax Make 1800VA(15A max) Break 180VA(1.5A max)
TH-N12(CX)☆*1	0.35A(0.28~0.42),0.5A(0.4~0.6),0.7A(0.55~0.85),0.9A(0.7~1.1),		
TH-N12(CX)HZKP★*2	1.3A(1~1.6),1.7A(1.4~2),2.1A(1.7~2.5),2.5A(2~3),3.6A(2.8~4.4),		
TH-N12(CX)HZ★*1	5A(4~6),6.6A(5.2~8),9A(7~11),11A(9~13)		
TH-N18(CX)KP☆	1.3A(1~1.6),1.7(1.4~2),2.1A(1.7~2.5),2.5A(2~3),3.6A(2.8~4.4),	S-N18	Break 180VA(1.5A max)
TH-N18(CX)☆*1	5A(4~6),6.6A(5.2~8),9A(7~11),11A(9~13),15A(12~18)		
TH-N20(CX)KP	0.24A(0.2~0.32),0.35A(0.28~0.42),0.5A(0.4~0.6),	S-N20 S-N21 S-N25 S-N35	
TH-N20(CX)☆*1	0.7A(0.55~0.85),0.9A(0.7~1.1),1.3A(1~1.6),1.7A(1.4~2),		
TH-N20CXHZKP★	2.1A(1.7~2.5),2.5A(2~3),3.6A(2.8~4.4),5A(4~6),6.6A(5.2~8),		
TH-N20CXHZ★*1	9A(7~11),11A(9~13),15A(12~18)		
TH-N20TAKP☆	22A(18~26)	S-N25,N35	
TH-N20TA☆*1	29A(24~34)	S-N35	
TH-N60KP	15A(12~18),22A(18~26),29A(24~34),35A(30~40),42A(34~50)	S-N50,N65,N80,N95	Rated Code / B600 AC600Vmax Make 3600VA(30A max) Break 360VA(3A max)
	54A(43~65)	S-N65,N80,N95	
TH-N60TAKP☆	67A(54~80)	S-N80,N95	
	82A(65~100)	S-N95	
TH-N120KP	42A(34~50),54A(43~65),67A(54~80),82A(65~100)	S-N125,N150	Break 360VA(3A max)
	105A(85~125)	S-N125,N150	
TH-N120TAKP☆	125A(100~150)	S-N150	
TH-N220RHKP☆	82A(65~100),105A(85~125),125A(100~150),150A(120~180)	S-N180,N220	
TH-N220HZKP★	180A(140~220)	S-N220	
TH-N400RHKP☆	105A(85~125),125A(100~150),150A(120~180),180A(140~220),250A(200~300)	S-N300,N400	
TH-N400HZKP★	330A(260~400)	S-N400	

- Notes: 1. ☆ is to be coupled with contactor and can not be mounted separately from contactor. ★ is only for separate mounting.
 2. Suffix "KP" ; Overload and phase failure protection type with three heater elements.
 3. *1 ; TH-N12(CX), N12(CX)HZ, N18(CX), N20(CX), N20CXHZ and N20TA are recognized (RUS) for single phase motors.
 4. *2 is to be coupled with TH-N12(CX)KP (c UL US) and UN-HZ12 (RUS).

■ Contactor Relay and Auxiliary Contact Block

Table 1.1.3 (3)

Type	Model Name	Rated Code;	Rated Code;	Mark
Contactor Relay	SR-N4 SRD-N4	A600	R300	c UL US
Auxiliary Contact Block	UN-AX2(CX) UN-AX4(CX) UN-AX11(CX)	AC600V max Make 7200VA Break 720VA	DC250V max Make 28VA Break 28VA	c UL US
	UN-AX80 UN-AX150			RUS

DC Interface Contactor

Table 1.1.3 (4)

Model Name		Horsepower rating [HP]					Continuous current rating [A]
		Single-phase (only non-reversing type)		three-phase			
Non-reversing type	Reversing type	110 ~ 120V	220 ~ 240V	200 ~ 208V	220 ~ 240V	440 ~ 480V	
SD-Q11	SD-QR11	$\frac{1}{3}$	1	3	3	5	20
SD-Q12	SD-QR12						13
MSOD-Q11(KP)	MSOD-QR11KP	$\frac{1}{2}$	$1\frac{1}{2}$	5	5	$7\frac{1}{2}$	30
MSOD-Q12(KP)	MSOD-QR12KP						18
SD-Q19	SD-QR19						
MSOD-Q19(KP)	MSOD-QR19KP						

Note: 1. MSOD-Q11, Q12 and Q19 are approved for single-phase circuits.

Solid state contactor (for motor/heater load)

Table 1.1.3 (5)

Model Name		Horsepower rating [HP]				Continuous current rating [A]
		Single-phase		three-phase		
3-pole,2-element type	3-pole,3-element type	100~120V	220~240V	220~240V	440~480V	
US-N5SS	US-N5SSTE	$\frac{1}{10}$	$\frac{1}{4}$	$\frac{3}{4}$	—	5
US-N8SS	US-N8SSTE	$\frac{1}{10}$	$\frac{1}{4}$	$\frac{3}{4}$	—	8
US-N20(CX)(RM)	US-N20TE(CX)(RM)	$\frac{1}{2}$	$1\frac{1}{2}$	3	5	20
US-N30(CX)	US-N30TE(CX)	1	3	5	10	30
US-N40(CX)	US-N40TE(CX)	2	3	$7\frac{1}{2}$	20	40
US-N50(CX)	US-N50TE(CX)	2	3	$7\frac{1}{2}$	20	50
US-N70NS	US-N70NSTE	3	$7\frac{1}{2}$	15	—	70
US-N80NS	US-N80NSTE	3	$7\frac{1}{2}$	15	—	80
US-NH70NS	US-NH70NSTE	3	$7\frac{1}{2}$	15	30	70
US-NH80NS	US-NH80NSTE	3	$7\frac{1}{2}$	15	30	80

Solid state contactor (for heater load)

Table 1.1.3 (6)

Model Name		Continuous current rating [A]
Batch control	Individual control	
US-H20(RM)(HZ)	US-H20DD(RM)(HZ)	20
US-H30(RM)	US-H30DD(RM)	30
US-H40	US-H40DD	40
US-H50	US-H50DD	50

Notes: 1. "(HZ)" has no cooling fin. "(RM)" is available rail mounting.

2. The US-H□ (DD) HZ type is certified at the continuous current rating when combined with the fin used on the US-H□ (DD) type.

3. The US-H□ (DD) HZ type is UR certified.

1.1.4 CCC Certified Products

Magnetic motor starters, etc., are designated as products targeted for China Compulsory Certification. CCC certification must be acquired before the product is exported to main land China from Domestic or marketed in China. The certified models are shown in Tables 1.1.4 (1-1) to 1.1.4 (8-2). The option units (UN-CV, ML, RR, SA, etc.) which are mounted on the magnetic motor starter and which do not have a load switching function are excluded from the CCC certification target.



Magnetic motor starter

With Enclosure

Table 1.1.4 (1-1)

Model Name MS : AC operated	Approval rating AC-3 Class (200~240V/380~440V)		Heater designation	Coil designation AC operated	Type ** application range (combination possible)	Number of aux. contacts Non-reversing Standard (special)	Certificate No.
	Rated capacity (kW)	Rated operational current (A)					
MS-N10CN**	2.5/4	11/9	0.12~9A	AC12V~AC500V	KP, SA, PM	1NO	20030103 04093078
MS-N11CN**	3.5/5.5	13/12	0.12~11A			1NO	
MS-N12CN**	3.5/5.5	13/12	0.12~11A			1NO1NC(2NO)	
MS-N20CN**	5.5/11	22/22	0.24~19A	AC12V~AC500V	KP, SA, PM	1NO1NC(2NO)	20030103 04093077
MS-N21CN**	5.5/11	22/22	0.24~19A			2NO2NC	
MS-N25CN**	7.5/15	30/30	0.24~22A			2NO2NC	
MS-N35CN**	11/18.5	40/40	0.24~35A	AC24V~AC500V	PM	2NO2NC	20030103 04093076
MS-N50CNKP**	15/22	55/50	15~54A			2NO2NC	
MS-N65CNKP**	18.5/30	65/65	15~54A			2NO2NC	
MS-N80CNKP**	22/45	85/85	15~67A	AC24V~AC500V	PM	2NO2NC	20030103 04093073
MS-N95CNKP**	30/55	105/105	15~95A			2NO2NC	
MS-N125CNKP	37/60	125/120	42~105A			2NO2NC	
MS-N150CNKP	45/75	150/150	42~125A	AC48V~AC500V	-	2NO2NC	20030103 04093067
MS-N180CNKP	55/90	180/180	82~150A			2NO2NC	
MS-N220CNKP	75/132	250/250	82~210A			2NO2NC	
MS-N300CNKP	90/160	300/300	105~250A	AC48V~AC500V	-	2NO2NC	20030103 04093079
MS-N400CNKP	125/220	400/400	105~330A			2NO2NC	
MS-N400CNKP	125/220	400/400	105~330A			2NO2NC	

Without Enclosure

Table 1.1.4 (1-2)

Model Name MSO : AC operated MSOD : DC operated 2X : Reversing type	Approval rating AC-3 Class (200~240V/380~440V)		Heater designation	Coil designation AC operated (MSO type) DC operated (MSOD type)	Type ** application range (combination possible)	Number of aux. contacts Non-reversing Standard (special)	Certificate No.
	Rated capacity (kW)	Rated operational current (A)					
MSO-(2X)N10**	2.5/4	11/9	0.12-9A	AC12V~AC500V	CX, KP, SA, SR	1NO(1NC)	20020103 04093078
MSO(D)-(2X)N11**	3.5/5.5	13/12	0.12-11A			1NO(1NC)	
MSO(D)-N12**	3.5/5.5	13/12	0.12-11A			1NO1NC(2NO)	
MSO-(2X)N18**	4.5/7.5	18/16	0.12-15A	DC12V~DC220V	CX, SA	-	20020103 04093077
MSO-(2X)N20**	5.5/11	22/22	0.24-19A			1NO1NC(2NO)	
MSO(D)-(2X)N21**	5.5/11	22/22	0.24-19A			2NO2NC	
MSO-(2X)N25**	7.5/15	30/30	0.24-22A	AC24V~AC500V	CX, KP, SA, SR	2NO2NC	20020103 04093076
MSO(D)-(2X)N35**	11/18.5	40/40	0.24-35A			2NO2NC	
MSO(D)-(2X)N50KP**	15/22	55/50	15-42A			2NO2NC	
MSO(D)-(2X)N65KP**	18.5/30	65/65	15-54A	AC24V~AC500V	CX, SR	2NO2NC	20020103 04093073
MSO(D)-(2X)N80KP**	22/45	85/85	15-67A			2NO2NC	
MSO(D)-(2X)N95KP**	30/55	105/105	15-95A			2NO2NC	
MSO(D)-(2X)N125KP**	37/60	125/120	42-105A	DC12V~DC220V	CX, SR	2NO2NC	20020103 04093064
MSO(D)-(2X)N150KP**	45/75	150/150	42-125A			2NO2NC	
MSO-(2X)N180KP**	55/90	180/180	82-150A			2NO2NC	
MSO(D)-(2X)N220KP**	75/132	250/250	82-210A	AC48V~AC500V	SR	2NO2NC	20020103 04093067
MSO(D)-(2X)N300KP**	90/160	300/300	105-250A			2NO2NC	
MSO(D)-(2X)N400KP**	125/220	400/400	105-330A			2NO2NC	
MSO(D)-(2X)N400KP**	125/220	400/400	105-330A	DC12V~DC220V	SR	2NO2NC	20020103 04093070
MSO(D)-(2X)N220KP**	75/132	250/250	82-210A			2NO2NC	
MSO(D)-(2X)N300KP**	90/160	300/300	105-250A			2NO2NC	
MSO(D)-(2X)N400KP**	125/220	400/400	105-330A	DC12V~DC220V	SR	2NO2NC	20020103 04093066
MSO(D)-(2X)N220KP**	75/132	250/250	82-210A			2NO2NC	
MSO(D)-(2X)N300KP**	90/160	300/300	105-250A			2NO2NC	

Notes: 1. The MSO-(2X)N10KP, MSO(D)-(2X)N11KP or MSO(D)-N12KP type with heater designation 0.12A and 0.17A are not certified.
2. MSO-(2X)N18KP type is not certified.

Magnetic Contactors

General Type Contactors

Table 1.1.4 (2-1)

Model Name S : AC operated SD : DC operated 2X : Reversing type	Approval rating AC-3 Class (200~240V/380~440V)		Conventional free air thermal current lth (A)	Coil designation AC operated (S type) DC operated (SD type)	Type ** application range (combination possible)	Number of aux. contacts Non-reversing Standard (special)	Certificate No.		
	Rated capacity (kW)	Rated operational current (A)							
S-(2X)N10**	2.5/4	11/9	20	AC12V~AC500V DC12V~DC220V	CX, SA	1NO (1NC)	20020103 04023375		
S(D)-(2X)N11**	3.5/5.5	13/12	20			1NO (1NC)			
S(D)-N12**	3.5/5.5	13/12	20			1NO1NC(2NO)			
S-(2X)N18**	4.5/7.5	18/16	25			—	20020103 04023377		
S-(2X)N20**	5.5/11	22/22	32			1NO1NC (2NO)			
S(D)-(2X)N21**	5.5/11	22/22	32			2NO2NC			
S-(2X)N25**	7.5/15	30/30	50			2NO2NC			
S(D)-(2X)N35**	11/18.5	40/40	60			AC24V~AC500V DC12V~DC220V	CX	2NO2NC	20020103 04024704
S(D)-(2X)N50**	15/22	55/50	80					2NO2NC	
S(D)-(2X)N65**	18.5/30	65/65	100					2NO2NC	20020103 04024705
S(D)-(2X)N80	22/45	85/85	135					2NO2NC	
S(D)-(2X)N95	30/55	105/105	150					2NO2NC	20020103 04024706
S(D)-(2X)N125	37/60	125/120	150					2NO2NC	20020103 04024707
S(D)-(2X)N150	45/75	150/150	200					2NO2NC	20020103 04024708
S-(2X)N180	55/90	180/180	260	2NO2NC					
S(D)-(2X)N220	75/132	250/250	260	AC48V~AC500V DC12V~DC220V	2NO2NC			20020103 04024709	
S(D)-(2X)N300	90/160	300/300	350		2NO2NC				
S(D)-(2X)N400	125/220	400/400	450		2NO2NC				
S(D)-(2X)N600CN	190/330	630/630	660		AC100V~AC500V DC24V~DC220V			2NO2NC	20030103 04095569
S(D)-(2X)N800CN	220/440	800/800	800	2NO2NC					

Mechanically Latched Contactors

Table 1.1.4 (2-2)

Model Name SL : AC operated SLD : DC operated 2X : Reversing type	Approval rating AC-3 Class (200~240V/380~440V)		Conventional free air thermal current lth (A)	Coil designation AC operated (SL type) DC operated (SLD type)	Type ** application range (combination possible)	Number of aux. contacts Non-reversing Standard	Certificate No.
	Rated capacity (kW)	Rated operational current (A)					
SL(D)-(2X)N21**	5.5/11	22/22	32	AC100V~AC500V DC12V~DC200V	CX, SA	2NO2NC	20020103 04023377
SL(D)-(2X)N35**	11/18.5	40/40	60			2NO2NC	
SL(D)-(2X)N50**	15/22	55/50	80		CX	2NO2NC	20020103 04024704
SL(D)-(2X)N65**	18.5/30	65/65	100			2NO2NC	
SL(D)-(2X)N80	22/45	85/85	135		—	2NO2NC	20020103 04024705
SL(D)-(2X)N95	30/55	105/105	150			2NO2NC	
SL(D)-(2X)N125	37/60	125/120	150			2NO2NC	20020103 04024706
SL(D)-(2X)N150	45/75	150/150	200			2NO2NC	20020103 04024707
SL(D)-(2X)N220	75/132	250/250	260		—	2NO2NC	20020103 04024708
SL(D)-(2X)N300	90/160	300/300	350			2NO2NC	
SL(D)-(2X)N400	125/220	400/400	450		AC100V~AC500V DC24V~DC200V	2NO2NC	20020103 04024709
SL(D)-(2X)N600CN	190/330	630/630	660			2NO2NC	
SL(D)-(2X)N800CN	220/440	800/800	800		—	1NO2NC	20030103 04095569

3-Pole Contactors

Table 1.1.4 (2-3)

Model Name S : AC operated 2X : Reversing type	Approval rating AC-3 Class (200~240V/380~440V)		Conventional free air thermal current lth (A)	Coil designation AC operated (S type)	Type ** application range (combination possible)	Number of aux. contacts Non-reversing Standard	Certificate No.
	Rated capacity (kW)	Rated operational current (A)					
S-(2X)N18**	4.5/7.5	18/16	25	AC12V~AC500V	CX, SA	—	20020103 04023377
S-(2X)N28**	7.5/7.5	26/17	30			—	
S-(2X)N38**	11/15	39/32	60			—	
S-(2X)N48**	15/18.5	50/40	80			—	20020103 04024684

NC Main Contact Type Contactors

Table 1.1.4 (2-4)

Model Name B : AC operated BD : DC operated	Main contact Arrangement	Certification ratings (A)			Conventional free air thermal current lth (A)	Coil designation AC operated (B type) DC operated (BD type)	Type ** application range (combination possible)	Number of aux. contacts Non-reversing	Certificate No.
		Number of series	DC-3,5 NC	DC-1 NC					
B(D)-N20CN**	B: 1NO2NC, 3NC	DC110V 2P	8	15	25	AC12V~AC500V	SA	2NO	20020103 04023377
		3P	15	20					
		DC220V 2P	1	5					
B(D)-N65CN	BD: 1NO2NC	3P	5	10	80	AC24V~AC500V DC12V~DC220V	—	2NO2NC	20020103 04024705
		DC110V 2P	20	30					
		3P	50	65					
B(D)-N100CN	B:1NO2NC BD:1NO2NC	DC220V 2P	3	10	120	—	2NO2NC	20020103 04024706	
		3P	20	30					
		DC110V 2P	30	40					

■ Thermal overload relay

● Three heater type with phase failure protection

Table 1.1.4 (3-1)

Model Name	Heater designation	Type ** application range (combination possible)	Combination magnetic contactor	Certificate No.
TH-N12KP**	0.24A, 0.35A, 0.5A, 0.7A, 0.9A, 1.3A, 1.7A, 2.1A, 2.5A, 3.6A, 5A, 6.6A, 9A, 11A	CX, HZ	S-N10~N12	20020103 09024710
TH-N20KP**	0.24A, 0.35A, 0.5A, 0.7A, 0.9A, 1.3A, 1.7A, 2.1A, 2.5A, 3.6A, 5A, 6.6A, 9A, 11A, 15A	CX, HZ, SR	S-N20~N35	20020103 09024712
TH-N20TAKP**	22A, 29A	CX, SR	S-N25, N35	
TH-N60KP**	15A, 22A, 29A, 35A, 42A, 54A	CX, SR	S-N50~N95	20020103 09024714
TH-N60TAKP**	67A, 82A	SR	S-N80, N95	
TH-N120KP**	42A, 54A, 67A, 82A	HZ, SR	S-N125, N150	20020103 09024724
TH-N120TAKP**	105A, 125A	SR		
TH-N220RHKP**	82A, 105A, 125A, 150A, 180A, 210A ²	SR	S-N180, N220	20020103 09024719
TH-N220HZKP**			Dedicated for independent mounting	
TH-N400RHKP**	105A, 125A, 150A, 180A, 250A, 330A		S-N300, N400	
TH-N400HZKP**			Dedicated for independent mounting	
TH-N600KP**	250A, 330A, 500A, 660A		Dedicated for independent mounting	20030103 04095454

Note: 1. The TH-N12KP** type with heater designation 0.12A and 0.17A, and the TH-N18KP** type are not certified.

2. Heater designation 210A are certified for S-N220 type.

● Two heater type

Table 1.1.4 (3-2)

Model Name	Heater designation	Type ** application range (combination possible)	Combination magnetic contactor	Certificate No.
TH-N12**	0.12A, 0.17A, 0.24A, 0.35A, 0.5A, 0.7A, 0.9A, 1.3A, 1.7A, 2.1A, 2.5A, 3.6A, 5A, 6.6A, 9A, 11A	CX, HZ, SR	S-N10~N12	20020103 09024701
TH-N18**	1.3A, 1.7A, 2.1A, 2.5A, 3.6A, 5A, 6.6A, 9A, 11A, 15A	CX, DM	S-N18	20020103 09024702
TH-N20**	0.24A, 0.35A, 0.5A, 0.7A, 0.9A, 1.3A, 1.7A, 2.1A, 2.5A, 3.6A, 5A, 6.6A, 9A, 11A, 15A	CX, HZ, SR	S-N20~N35	20020103 09024703
TH-N20TA**	22A, 29A, 35A ¹	CX, SR	S-N25, N35	

Note: 1. Heater designation 35A are certified for S-N35 type.

■ Auxiliary contact block

Table 1.1.4 (4)

Model Name	Available contact arrangements	Type ** application range (combination possible)	Applicable magnetic contactor	Certificate No.
UN-AX2CN**	2NO, 1NO1NC	CX	S-N10~N65	20020103 03024700
UN-AX4CN**	4NO, 3NO1NC, 2NO2NC		S-N10, N11, N20~N65	
UN-AX11CN**	1NO1NC			
UN-AX80CN	1NO1NC	-	S-N80~N125	20020103 03024720
UN-AX150CN	1NO1NC		S-N150~N400	20020103 03024722
UN-AX600CN	2NO2NC			
UN-LL22CN**	1NO1NC(low level), 1NO1NC(standard)		CX	S-N10~N65, SR-N4

■ DC interface contactor

● Magnetic motor starter

Table 1.1.4 (5-1)

Model Name Q : Non-reversing type QR : Reversing type	Approval rating AC-3 Class (200~240V/380~440V)		Heater designation	Coil designation DC operation	Type ** application range (combination possible)	Number of aux. contacts Standard (special)	Certificate No.
	Rated capacity (kW)	Rated operational current (A)					
MSOD-Q11**	3/4	12/9	0.12~11A	DC24V	CX, KP	1NO(1NC)	20030103 04093069
MSOD-Q12**						1NO1NC(2NO)	
MSOD-Q19**	4.5/5.5	18/13	1.3~15A		CX	1NO1NC(2NO)	20030103 04093080
MSOD-QR11**	3/4	12/9	0.12~11A		DC24V	CX, KP	2NC
MSOD-QR12**				2NO2NC			
MSOD-QR19**	4.5/5.5	18/13	1.3~15A		CX	2NO2NC	20030103 04093080

Note: 1. Heater designation 0.12A and 0.17A are not certified for MSOD-Q11KP and Q12KP types.

● Magnetic contactor

Table 1.1.4 (5-2)

Model Name Q : Non-reversing type QR : Reversing type	Approval rating AC-3 Class (200~240V/380~440V)		Conventional free air thermal current Ith (A)	Coil designation DC operation	Number of aux. contacts Standard (special)	Certificate No.
	Rated capacity (kW)	Rated operational current (A)				
SD-Q11	3/4	12/9	20	DC24V	1NO(1NC)	20030103 04095567
SD-Q12					1NO1NC(2NO)	
SD-Q19	4.5/5.5	18/13	30		1NO1NC(2NO)	20030103 04086213
SD-QR11	3/4	12/9	20	DC24V	2NC	20030103 04095567
SD-QR12					2NO2NC	
SD-QR19	4.5/5.5	18/13	30			2NO2NC

■ Contactor Relays

Table 1.1.4 (6)

Model Name SR : AC operated SRD : DC operated SRL : AC operated SRLD : DC operated	Coil designation	Type ** application range (combination possible)	Available contact arrangement	Certificate No.
	AC operated (SR, SRL type) DC operated (SRD, SRLD type)			
SR-N4**	AC12V-AC440V	CX, SA	4NO, 3NO1NC, 2NO2NC	20020103 03024696
SRD-N4**	DC12V-DC220V			
SRL-N4**	AC100V-AC440V			
SRLD-N4**	DC12V-DC200V			

■ Pneumatic Time Delay Relays

Table 1.1.4 (7)

Model Name SRT : AC operated SRTD : DC operated	Coil designation	Type ** application range (combination possible)	Available contact arrangement	Certificate No.
	AC operated (SRT type) DC operated (SRTD type)			
SRT(D)-NNCN**	AC12V-AC440V	CX, SA	Instantaneous : 2NO2NC	20050103 03152666
SRT(D)-NFCN**	DC12V-DC220V		Delayed : 1NO1NC	

■ Solid State Contactors

• 2-elements type

Table 1.1.4 (8-1)

Model Name	Approval rating AC-51 class (A)	3-ph Heater capacity 220/380V AC-51 (kW)	3-ph Motor capacity 220-240/380-440V AC-53a (kW(A))	Rated operating voltage	Type ** application range (combination possible)	Certificate No.
US-N5SS**	5	1.9/-	0.4 (3.2) /-	DC12~24V	-	20060103 04174448
US-N8SS**	8	3.0/-	0.4 (3.2) /-		-	
US-N20**	20	7.6/13.1	2.2 (11.1) /3.7 (8.7)		CX, RM	20050103 04162980
US-N30**	30	11.4/19.7	3.7 (17.4) /7.5 (17.4)		CX	
US-N40**	40	15.2/26.3	5.5 (26) /11 (26)			
US-N50**	50	19.0/32.9	5.5 (26) /11 (26)			
US-N70NS**	70	26.6/-	11 (48) /-		-	20060103 04174451
US-N80NS**	80	30.4/-	11 (48) /-			
US-NH70NS**	65	24.7/42.7	11 (48) /22 (48)			
US-NH80NS**	75	28.5/49.3	11 (48) /22 (48)			

• 3-elements type

Table 1.1.4 (8-2)

Model Name	Approval rating AC-51 class (A)	3-ph Heater capacity 220/380V AC-51 (kW)	3-ph Motor capacity 220-240/380-440V AC-53a (kW(A))	Rated operating voltage	Type ** application range (combination possible)	Certificate No.
US-N5SSTE	5	1.9/-	0.4 (3.2) /-	DC12~24V	-	20060103 04174448
US-N8SSTE	8	3.0/-	0.4 (3.2) /-		-	
US-N20TE**	20	7.6/13.1	2.2 (11.1) /3.7 (8.7)		CX, RM	20050103 04162980
US-N30TE**	30	11.4/19.7	3.7 (17.4) /7.5 (17.4)		CX	
US-N40TE**	40	15.2/26.3	5.5 (26) /11 (26)			
US-N50TE**	50	17.1/29.6	5.5 (26) /11 (26)			
US-N70NSTE	70	26.6/-	11 (48) /-		-	20060103 04174451
US-N80NSTE	80	30.4/-	11 (48) /-			
US-NH70NSTE	65	24.7/42.7	11 (48) /22 (48)			
US-NH80NSTE	75	28.5/49.3	11 (48) /22 (48)			

■ Medium Voltage Vacuum Contactors

Table 1.1.4 (9)

Model Name SH : AC operated SHD : DC operated SL : Mechanical Latched(AC operated) SLD : Mechanical Latched(DC operated)	Approval rating AC-3 Class (200~240V/380~440V/1000V)		Conventional free air thermal current Ith (A)	Coil designation	Number of aux. contacts Standard	Certificate No.
	Rated capacity (kW)	Rated operational current (A)				
SH(D)-V160CN	45/90/220	180/180/160	200	AC100V-AC500V DC100V, DC200V	2a2b	20060103 04201618
SH(D)-V320CN	75/150/400	320/320/320	350			
SH(D)-V400CN	95/200/500	400/400/400	450			
SHL(D)-V160CN	45/90/220	180/180/160	200	AC100V-AC500V DC100V, DC200V	SHL : 2a2b SHLD : 2a4b	20060103 04201618
SHL(D)-V320CN	75/150/400	320/320/320	350			
SHL(D)-V400CN	95/200/500	400/400/400	450			

■ Voltage Detection Relays

Table 1.1.4 (10)

Model Name	Detectable voltage range Min~Max	Output contact arrangement	Certificate No.
SRE-AACN	AC3V-AC250V	1c	20070103 03224330
SRE-AAUCN	DC0.1V-DC250V		
SRE-KCN	AC75V-AC250V, DC9V-DC105V		
SRE-KTCN	AC80V-AC260V, DC10V-DC115V		

■ Solid State Time Delay Relays

Table 1.1.4 (11)

Model Name	Control voltage designation	Output contact arrangement	Certificate No.
SRS-HNPSCN	AC100V, AC200V, AC400V	Instantaneous : 1c, Delayed : 1c	20070103 03224347

1.1.5 Approved Marine Standards

■ Lloyd's Register of Shipping (LR) 

■ Bureau Veritas (BV) 

Table 1.1.5 (1)

Type	Model Name	BV Certificate No.	LR Certificate No.	Note
Contactor	S-N10, N11, N12, N20, N21(CX)	06139	95/10008	AC-3 Maximum 550V Standard model can be applied.
	SD-N11, N12, N21(CX)(SA)	2634/6987	96/10035	
	S-N18, N25, N28, N35(CX)(SA)/SD-N35(CX)(SA)	2634/6988	96/10034	
	S/SD-N50, N65, N80, N95	2634/07905	98/10016	
	S/SD-N125, N150, N220, N300, N400, S-N180	2634/07905	98/10016	
	S/SD-N600, N800	2634/07905	98/10016	
Thermal Overload Relay	TH-N12 (CX)(KP), N20(CX)(KP)	06139	95/10009	Maximum 550V Standard model can be applied.
	TH-N18(CX)(KP), N20TA(CX)(KP)	2634/6988	96/10033	
	TH-N60(KP), N60TA(KP), N120(KP), N120TA(KP), N220(KP), N400(KP)	2634/07905	98/10017	
	TH-N600(KP)	2634/07905	98/10017	
Contactor Relay	SR-N4(CX)	06139	95/10010	AC-15 Maximum 550V Standard model can be applied.
	SRD-N4(CX)	2634/6987	96/10035	
Auxiliary Contact Block	UN-AX2, AX4, AX11(CX)	06139	95/10010	Standard model can be applied.
	UN-AX80, AX150, AX600	2634/07905	98/10016	

■ Korean Register of Shipping (KR) 

Table 1.1.5 (2)

Contactor Model Name	Certificate No.	Contactor Model Name	Certificate No.	Contactor Model Name	Certificate No.
S-N10(CX)	KOB02571-EL020	S-N21(CX)	KOB02571-EL020	S-N95	KOB02571-EL020
S-KR11	KOB02571-EL018	S-N25(CX)(SA)	KOB02571-EL020	S-N125	KOB02571-EL020
S-N11(CX)	KOB02571-EL020	S-N35(CX)(SA)	KOB02571-EL020	S-N150	KOB02571-EL020
S-N12(CX)	KOB02571-EL020	S-N50	KOB02571-EL020	S-N220	KOB02571-EL020
S-N18(CX)(SA)	KOB02571-EL020	S-N65	KOB02571-EL020	S-N300	KOB02571-EL020
S-N20(CX)	KOB02571-EL020	S-N80	KOB02571-EL020	S-N400	KOB02571-EL020

Note: 1. Standard models are applicable. (AC3 Max. 440V according to JEM standard.)

■ Nippon Kaiji Kyokai (NK) 

Table 1.1.5 (3)

Contactor Model Name	Certificate No.	Contactor Model Name	Certificate No.	Contactor Model Name	Certificate No.		
S-N10(CX)	—	94T415	S-N125	SD-N125	98T407	SL(D)-N21NK	95T401
S-KR11	—	85T405	S-N150	SD-N150	98T408	SL(D)-N35NK	96T401
S-N11(CX)	SD-N11(CX)	94T416	S-N180	—	98T409	SL(D)-N50NK	98T413
S-N12(CX)	SD-N12(CX)	94T417	S-N220	SD-N220	98T410	SL(D)-N65NK	98T414
S-N18(CX)(SA)	—	95T404	S-N300	SD-N300	98T411	SL(D)-N80NK	98T415
S-N20(CX)	—	94T418	S-N400	SD-N400	98T412	SL(D)-N95NK	98T416
S-N21(CX)	SD-N21(CX)	94T419	S-N600	SD-N600	85T406	SL(D)-N125NK	98T417
S-N25(CX)(SA)	—	95T402	S-N800	SD-N800	85T407	SL(D)-N150NK	98T418
S-N35(CX)(SA)	SD-N35(CX)(SA)	95T403 96T401	S-N38(CX)(SA)	—	96T402	SL(D)-N220NK	98T419
S-N50	SD-N50	98T403	S-N48(CX)(SA)	—	96T403	SL(D)-N300NK	98T420
S-N65	SD-N65	98T404	B-N20	BD-N20	96T404	SL(D)-N400NK	98T421
S-N80	SD-N80	98T405	B-N65	BD-N65	01T401	SL(D)-N600NK	85T408
S-N95	SD-N95	98T406	B-N100	BD-N100	01T402	SL(D)-N800NK	85T409

Note: 1. Standard models are applicable. (AC3 Max. 440V according to JEM standard.)

1.2 Selection Guide



S-N11CX



S-2xN11



MSO-N12



S-N21CX



MSO-N35

Three-phase motor ratings IEC category AC-3 kW(hp)	220-240V	2.5(3-1/4)	3.5(4-1/2)	3.5(4-1/2)	4.5(6)	5.5(7-1/2)	5.5(7-1/2)	7.5(10)	11(15)
	380-440V	4(5-1/2)	5.5(7-1/2)	5.5(7-1/2)	7.5(10)	11(15)	11(15)	15(20)	18.5(25)
	500V	4(5-1/2)	5.5(7-1/2)	5.5(7-1/2)	7.5(10)	11(15)	11(15)	15(20)	18.5(25)
	690V	4(5-1/2)	5.5(7-1/2)	5.5(7-1/2)	7.5(10)	7.5(10)	7.5(10)	11(15)	15(20)
Conventional free air thermal current Ith A		20	20	20	25	32	32	50	60
Auxiliary contacts ¹	(standard)	1NO	1NO	1NO+1NC	— ²	1NO+1NC	2NO+2NC	2NO+2NC	2NO+2NC
	(special)	1NC	1NC	2NO	—	2NO	—	—	—
Number of additional auxiliary contact block for ³	1NO + 1NC (front)	1	1	1	1	1	1	1	1
	1NO + 1NC (side)	2	2	—	—	2	2	2	2
	2NO + 2NC (front)	1	1	1	1	1	1	1	1
	Low level signal (front) [1NO+1NC (+Standard 1NO + 1NC)]	1	1	1	1	1	1	1	1

Notes: 1. Number of auxiliary contact shows that for non-reversing type. Twice of the auxiliary contacts are provided on reversing type.
 2. (2NO + 2NC) × 2 auxiliary contacts are provided on reversing type and no additional contact can be mounted.
 3. Front clip-on and side clip-on block should not be mounted both.

Contactors

AC operated models	Non-reversing	S-N10(CX)	S-N11(CX)	S-N12(CX)	S-N18(CX)	S-N20(CX)	S-N21(CX)	S-N25(CX)	S-N35(CX)
	Reversing	S-2xN10(CX)	S-2xN11(CX)	—	S-2xN18(CX)	S-2xN20(CX)	S-2xN21(CX)	S-2xN25(CX)	S-2xN35(CX)
DC operated models		—	SD-N11(CX)	SD-N12(CX)	—	—	SD-N21(CX)	—	SD-N35(CX)

Note: 1. Products which model names are provided with suffix “CX” are provided with finger protection. (N10~N65)
 Especially N10~N35 with suffix “CX” are provided with CAN terminals.

Staters (AC operated)

Enclosed type (IP20)	MS-N10 (KP)	MS-N11 (KP)	MS-N12 (KP)	—	MS-N20 (KP)	MS-N21 (KP)	MS-N25 (KP)	MS-N35 (KP)
Open type (IP00)	MSO-N10 (KP)(CX)	MSO-N11 (KP)(CX)	MSO-N12 (KP)(CX)	MSO-N18 (KP)(CX)	MSO-N20 (KP)(CX)	MSO-N21 (KP)(CX)	MSO-N25 (KP)(CX)	MSO-N35 (KP)(CX)



Thermal Overload Relays¹

Three heater type with phase failure protection	TH-N12KP(CX)	TH-N18KP(CX)	TH-N20KP(CX)	TH-N20TAKP(CX)
Two heater type	TH-N12(CX)	TH-N18(CX)	TH-N20(CX)	TH-N20TA(CX)
Heater setting range A (Ordering designation)	0.1~0.16(0.12A) 0.14~0.22(0.17A) 0.2~0.32(0.24A) 0.28~0.42(0.35A) 0.4~0.6(0.5A) 0.55~0.85(0.7A) 0.7~1.1(0.9A) 1~1.6(1.3A) 1.4~2(1.7A)	1.7~2.5(2.1A) 2~3(2.5A) 2.8~4.4(3.6A) 4~6(5A) 5.2~8(6.6A) 7~11(9A) 9~13(11A) ²	1~1.6(1.3A) 1.4~2(1.7A) 1.7~2.5(2.1A) 2~3(2.5A) 2.8~4.4(3.6A) 4~6(5A) 5.2~8(6.6A) 7~11(9A) 9~13(11A) 12~18(15A)	0.2~0.32(0.24A) 0.28~0.42(0.35A) 0.4~0.6(0.5A) 0.55~0.85(0.7A) 0.7~1.1(0.9A) 1~1.6(1.3A) 1.4~2(1.7A) 1.7~2.5(2.1A)
				2~3(2.5A) 2.8~4.4(3.6A) 4~6(5A) 5.2~8(6.6A) 7~11(9A) 9~13(11A) 12~18(15A) 16~22(19A) ³
				18~26(22A) 24~34(29A) 30~40(35A) ⁴

Notes: 1. Saturable reactors for thermal overload relays are available as a kit or equipped with the relay. The suffix “SR” following the model name of the relay indicates “with saturable reactor”. (ex. TH-N20KPSR*5A) (Except for type TH-N12KP, TH-N18 and TH-N18KP)
 2. Except for size N10.
 3. For size N20 & N21 only.
 4. For size N35 only.

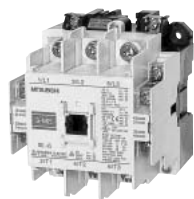

S-N65



S-N125



S-N400



S-N800

Table 1.2.1

15(20)	18.5(25)	22(30)	30(40)	37(50)	45(60)	55(75)	75(100)	90(125)	125(170)	190(250)	220(300)
22(30)	30(40)	45(60)	55(75)	60(80)	75(100)	90(125)	132(180)	160(210)	220(300)	330(450)	440(600)
25(34)	37(50)	45(60)	55(75)	60(80)	90(125)	110(150)	132(180)	160(210)	225(330)	330(450)	500(670)
22(30)	30(40)	45(60)	55(75)	60(80)	90(125)	110(150)	132(180)	200(270)	250(330)	330(450)	500(670)
80	100	135	150	150	200	260	260	350	450	800	1000
2NO+2NC	2NO+2NC	2NO+2NC	2NO+2NC	2NO+2NC	2NO+2NC	2NO+2NC	2NO+2NC	2NO+2NC	2NO+2NC	2NO+2NC	2NO+2NC
—	—	—	—	—	—	—	—	—	—	—	—
—	—	—	—	—	—	—	—	—	—	—	—
—	—	2	2	2	2	2	2	2	2	—	—
1	1	—	—	—	—	—	—	—	—	1	1
—	—	—	—	—	—	—	—	—	—	—	—

S-N50(CX)	S-N65(CX)	S-N80	S-N95	S-N125	S-N150	S-N180	S-N220	S-N300	S-N400	S-N600	S-N800
S-2×N50(CX)	S-2×N65(CX)	S-2×N80	S-2×N95	S-2×N125	S-2×N150	S-2×N180	S-2×N220	S-2×N300	S-2×N400	S-2×N600	S-2×N800
SD-N50	SD-N65	SD-N80	SD-N95	SD-N125	SD-N150	—	SD-N220	SD-N300	SD-N400	SD-N600	SD-N800

MS-N50 (KP)	MS-N65 (KP)	MS-N80 (KP)	MS-N95 (KP)	MS-N125 (KP)	MS-N150 (KP)	MS-N180 (KP)	MS-N220 (KP)	MS-N300 (KP)	MS-N400 (KP)	—	—
MSO-N50 (KP)(CX)	MSO-N65 (KP)(CX)	MSO-N80 (KP)	MSO-N95 (KP)	MSO-N125 (KP)	MSO-N150 (KP)	MSO-N180 (KP)	MSO-N220 (KP)	MSO-N300 (KP)	MSO-N400 (KP)	—	—

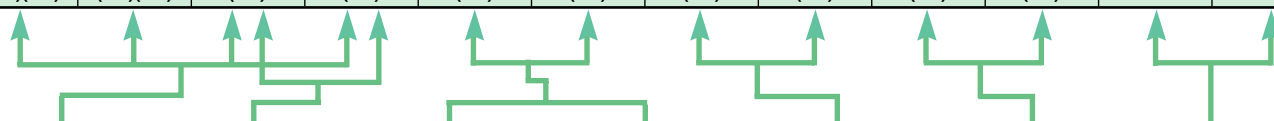

TH-N60KP(CX)	TH-N60TAKP	TH-N120KP	TH-N120TAKP	TH-N220RHKP	TH-N400RHKP	TH-N600KP ⁹
TH-N60(CX)	TH-N60TA	TH-N120	TH-N120TA	TH-N220RH	TH-N400RH	TH-N600 ⁹
12~18(15A) 18~26(22A) 24~34(29A) 30~40(35A) 34~50(42A) 43~65(54A)	54~80 (67A) 65~100(82A) 85~105(95A) ⁵	34~50 (42A) 43~65 (54A) 54~80 (67A) 65~100(82A)	85~125 (105A) 100~150(125A) ⁶	65~100 (82A) 85~125 (105A) 100~150(125A) 120~180(150A) 140~220(180A) ⁷ 170~250(210A) ⁷	85~125 (105A) 100~150(125A) 120~180(150A) 140~220(180A) 200~300(250A) 260~400(330A) ⁸	200~300(250A) 260~400(330A) 400~600(500A) 520~800(660A) ¹⁰

5. For size N95 only.

6. For size N150 only.

7. For size N220 only.

8. For size N400 only.

9. TH-N600(KP) must be used with the current transformers (to be supplied by the customer.) See Table 2.1.2.

10. For size N800 only.

1.3 The Overview (Type designation breakdown)

1.3.1 Non-Reversing Types

Table 1.3.1

Frame Size			N10	N11	N12	N18	N20	N21	N25	N35	N50	N65	N80	N95	N125	N150	N180	N220	N300	N400	N600	N800		
Spec	Rated capacity	220-240V	2.5	3.5	3.5	4.5	5.5	5.5	7.5	11	15	18.5	22	30	37	45	55	75	90	125	190	220		
	Category AC-3(kW)	380-440V	4	5.5	5.5	7.5	11	11	15	18.5	22	30	45	55	60	75	90	132	160	220	330	440		
Spec	Number of aux. contacts	Standard	1NO	1NO	1NO1NC	—	1NO1NC	← 2NO2NC →																
		Special	1NC	1NC	2NO	—	2NO	—	—	—	—	—	—	—	—	—	—	—	—	—	—	—	—	
ACCESSORIES	Additional aux. contact blocks	Front-on ¹	← 2P or 4P →										—	—	—	—	—	—	—	—	—	—		
		Side-on	← 1NO1NC×2(max.) →		—	← 1NO1NC×2(max.) →															2NO2NC×1(max.)			
	Surge absorber ³	← Attachable →										← Provided as a standard →												
	Mechanical interlock unit		← Attachable →		—	← Attachable →															—	—		
CONTACTORS	Open	AC operated	S-□	○	○	○	○	○	○	○	○	○	○	○	○	○	○	○	○	○	○	○	○	
		DC operated	SD-□	—	○	○	—	—	○	—	○	○	○	○	○	○	○	○	—	○	○	○	○	○
		Finger protected	S-□CX	○	○	○	○	○	○	○	○	○	○	—	—	—	—	—	—	—	—	—	—	—
			SD-□CX	—	○	○	—	—	○	—	○	—	—	—	—	—	—	—	—	—	—	—	—	—
	Mechanically latched	SL(D)-□	—	—	—	—	—	○	—	○	○	○	○	○	○	○	—	○	○	○	○	○		
STARTERS	Open	AC operated	MSO-□	○	○	○	○	○	○	○	○	○	○	○	○	○	○	○	○	○	○	○	—	
		DC operated	MSOD-□	—	○	○	—	—	○	—	○	○	○	○	○	○	○	○	—	○	○	○	—	
		With phase failure protection	MSO-□KP	○	○	○	○	○	○	○	○	○	○	○	○	○	○	○	○	○	○	○	○	—
	Enclosed Class IP20	Slow trip type with saturable reactor	MSO-□SR	○	○	○	—	○	○	○	○	○	○	○	○	○	○	○	○	○	○	○	—	
		Quick-trip type with 2 heater elements	MSO-□FS	—	—	—	—	○	○	○	○	○	○	○	○	—	—	—	—	—	—	—	—	
		Quick-trip type with phase failure protection	MSO-□KF	○	○	○	—	○	○	○	○	○	○	○	○	—	—	—	—	—	—	—	—	
Enclosed Class IP20	Standard type	MS-□	○	○	○	—	○	○	○	○	○	○	○	○	○	○	○	○	○	○	○	—		
	With push button	MS-□PM	○	○	—	—	○	○	○	○	○	○	○	○	—	—	—	—	—	—	—	—		
	With phase failure protection	MS-□KP	○	○	○	—	○	○	○	○	○	○	○	○	○	○	○	○	○	○	○	—		
	Mounting on 35mm rail		← Available →										—	—	—	—	—	—	—	—	—			

Notes: 1. Additional head-on type aux. contact blocks cannot be attached to the enclosed type, mechanically latched type of size N50 & N65.
 2. Surge absorber is provided as a standard on ac operated contactors and starters of sizes N50 to N800.

1.3.2 Reversing Type

Table 1.3.2

Frame Size		2x N10	2x N11	2x N18	2x N20	2x N21	2x N25	2x N35	2x N50	2x N65	2x N80	2x N95	2x N125	2x N150	2x N180	2x N220	2x N300	2x N400	2x N600	2x N800			
Spec	Rated capacity	220-240V	2.5	3.5	4.5	5.5	5.5	7.5	11	15	18.5	22	30	37	45	55	75	90	125	190	220		
	Category AC-3(kW)	380-440V	4	5.5	7.5	11	11	15	18.5	22	30	45	55	60	75	90	132	160	220	330	440		
Spec	Number of aux. contacts	Standard	1NO1NCx2		2NO2NCx2	1NO1NCx2	2NO2NCx2										3NO3NCx2			4NO4NCx2			
		Special	—	—	—	—	—	—	—	—	—	—	—	—	—	—	—	—	—	—	—	—	
ACCESSORIES	Additional aux. contact blocks	Front-on ¹	4Px2 / 2Px2		—	4Px2 / 2Px2						—	—	—	—	—	—	—	—	—	—	—	
		Side-on	1NO1NCx2		—	1NO1NCx2										—	—	—	—	—	—		
	Surge absorber ²	Attachable										Provided as a standard											
CONTACTORS	Open	AC operated	S-□	○	○	○	○	○	○	○	○	○	○	○	○	○	○	○	○	○	○	○	
		DC operated	SD-□	—	○	—	—	○	—	○	○	○	○	○	○	○	—	○	○	○	○	○	○
		Finger protected	S-□CX	○	○	○	○	○	○	○	○	○	—	—	—	—	—	—	—	—	—	—	—
		Mechanically latched	SL(D)-□	—	—	—	—	○	—	○	○	○	○	○	○	○	—	○	○	○	○	○	○
		AC operated	MSO-□	○	○	○	○	○	○	○	○	○	○	○	○	○	○	○	○	○	○	○	○
STARTERS	Open	DC operated	MSOD-□	—	○	—	—	○	—	○	○	○	○	○	○	○	○	○	○	○	○	○	
		With phase failure protection	MSO-□KP	○	○	○	○	○	○	○	○	○	○	○	○	○	○	○	○	○	○	○	○
		Slow trip type	MSO-□SR	○	○	—	○	○	○	○	○	○	○	○	○	○	○	○	○	○	○	○	○
		Quick-trip type	MSO-□FS	—	—	—	○	○	○	○	○	○	○	—	—	—	—	—	—	—	—	—	—
		with phase failure protection	MSO-□KF	○	○	—	○	○	○	○	○	○	○	—	—	—	—	—	—	—	—	—	—
STARTERS	Enclosed(IP20)	Standard type	MS-□	—	—	○	○	○	○	○	○	○	○	○	○	○	○	○	○	○	○	○	
		With phase failure protection	MS-□KP	○	○	—	○	○	○	○	○	○	○	○	○	○	○	○	○	○	○	○	○
Mounting on 35mm rail		Available ³										—	—	—	—	—	—	—	—	—			

Notes: 1. Additional head-on type aux. contact blocks cannot be attached to the enclosed type, mechanically latched type of size N50 & N65.
 2. Surge absorber is provided as a standard on ac operated contactors and starters of sizes 2xN50 to 2xN800.
 3. Remove a mounting plate for mounting on 35mm rail of sizes 2xN25 to 2xN65.

1.4 Technical Data of Series S-N Contactors

1.4.1 Ratings and Characteristics

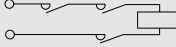
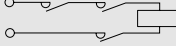
Contactor		Type	S/SD-				S/SD-		S/SD-		S/SD-	
			S-N10	N11, N12	S-N18	S-N20	N21	S-N25	N35	N50	N65	
Rated insulation voltage		V	690	690	690	690	690	690	690	690	690	
Conventional free air thermal current		lth	A	20	20	25	32	32	50	60	80	100
Rated capacity for resistive loads												
3-ph, Category AC-1	220-240V	kW(A)	7.5(20)	7.5(20)	9.5(25)	12(32)	12(32)	18(50)	20(60)	30(80)	35(100)	
	380-440V	kW(A)	7(11)	8.5(13)	13(20)	20(32)	20(32)	30(50)	35(60)	50(80)	65(100)	
	500V	kW(A)	7(8)	9.5(11)	13(16)	25(32)	25(32)	40(50)	50(60)	65(80)	85(100)	
	690V	kW(A)	7(6)	8(8)	11(10)	30(32)	30(32)	50(50)	60(60)	80(80)	100(100)	
Rated operational current												
3-ph, Category AC-3	220-240V	A	11	13	18	22	22	30	40	55	65	
	380-440V	A	9	12	16	22	22	30	40	50	65	
	500V	A	7	9	13	17	17	24	32	38	60	
	690V	A	5	7	9	9	9	12	17	26	38	
Rated capacity for jogging of AC motors												
3-ph, category AC-4	220-240V	kW	0.75	1.1	1.5	2.2	2.2	3	3.7	5.5	7.5	
	380-440V	kW	1.1	1.5	2.2	3.7	3.7	5.5	5.5	7.5	11	
	500V	kW	1.1	1.5	2.2	3.7	3.7	5.5	5.5	7.5	11	
	690V	kW	1.1	1.5	2.2	3.7	3.7	5.5	5.5	7.5	11	
Max. current for AC-4 duty at 440V		A	6	9	9	13	13	17	24	32	47	
Rated current for DC non-inductive loads												
Category DC-1	48V	A	10	12	12	20	20	25	35	50	65	
	110V	A	8	12	12	20	20	25	35	50	65	
	220V	A	8	12	12	20	20	22	30	40	50	
												
Rated Current for DC motors												
Category DC-2 & DC-4	48V	A	6	10	10	20	20	25	30	35	40	
	110V	A	4	8	8	15	15	20	20	30	35	
	220V	A	2	4	4	8	8	10	10	12	15	
												
Applicable standard: JEM-1038 (JAPAN)												
Rated capacity for 3-ph, capacitors ⁴												
120 operations/hour max.	220-240V	kvar	2.2	3	4	5.5	5.5	8.5	12	20	20	
	380-440V	kvar	3.3	4	6	10	10	14	20	40	40	
	550V	kvar	4	5	6	10	10	14	20	30	35	
	690V	kvar	3.3	4.5	5.5	10	10	14	20	30	40	
Making & breaking												
3-ph, cosθ=0.35 240V/440V	Making current	A	110/110	130/120	180/180	220/220	220/220	300/300	400/400	550/460	650/620	
	Breaking current	A	100/72	120/100	180/130	220/220	220/220	300/240	400/320	550/460	650/620	
Switching frequency												
	Category AC-1	operations/hour	1,800	1,800	1,800	1,800	1,800	1,800	1,800	1,200	1,200	
	Category AC-3	operations/hour	1,800	1,800	1,800	1,800	1,800	1,800	1,800	1,200	1,200	
	Category AC-4	operations/hour	600	600	600	600	600	600	600	600	600	
Operating time (at rated coil voltage)												
AC operated	Closing	ms	15	15	15	15	15	15	15	25	25	
	Opening	ms	10	10	10	10	10	10	10	53	53	
DC operated	Closing	ms	—	45	—	—	33	—	50	57	57	
	Opening	ms	—	10	—	—	12	—	13	15	15	
Coil consumption (at rated coil voltage)												
AC operated	Inrush	VA	45	45	60	90	90	110	110	115	115	
	Sealed	VA	7	7	10	15	15	13	13	20	20	
	Watts	W	2.4	2.4	3	4	4	4.3	4.3	2.2	2.2	
DC operated	Inrush	VA	—	7	—	—	9	—	9	18	18	
	Sealed	VA	—	7	—	—	9	—	9	18	18	
Coil voltage tolerance		0.85 to 1.1 times rated coil voltage										
Mechanical endurance (make/break operations)		million	10	10	10	10	10	10	10	5	5	
Permissible ambient temperature		°C	-25 to +55									
Vibration (10-55 Hertz)		m/s ²	19.6									
Shock (10 ms half sine wave)		m/s ²	49									
Conductor size	Main terminal (contactor)	mm ²	1-2.5	1-2.5	1-6	1-6	1-6	2-16	2-16	2-25	2-25	
	Main terminal (overload relay)	mm ²	1-2.5	1-2.5	1-6	1-6	1-6	2-16	2-16	2-25	2-25	
Control terminal		mm ²	1-2.5	1-2.5	1-2.5	1-2.5	1-2.5	1-2.5	1-2.5	1-2.5	1-2.5	
Busbar width		mm	—	—	—	—	—	—	—	—	—	

Notes: 1. 660A at ambient temperature 40-55°C. 2. 800A at ambient temperature 40-55°C.

3. Conductor size in parentheses indicate compression terminal style not for bare clamping.

4. The peak value of inrush current should be less than 2000% of the effective value for rated current of capacitors.

The selection is invalid for the circuit of parallel capacitors which are controlled individually.

Table 1.4.1 (1)

S/SD-N80	S/SD-N95	S/SD-N125	S/SD-N150	S-N180	S/SD-N220	S/SD-N300	S/SD-N400	S/SD-N600	S/SD-N800
690	690	690	690	690	690	690	690	690	690
135	150	150	200	260	260	350	450	800 ¹	1000 ²
50(135)	55(150)	55(150)	75(200)	95(260)	95(260)	130(350)	170(450)	250(660)	300(800)
85(135)	90(150)	90(150)	130(200)	170(260)	170(260)	230(350)	290(450)	430(660)	530(800)
110(135)	120(150)	120(150)	170(200)	220(260)	220(260)	300(350)	380(450)	570(660)	700(800)
135(135)	150(150)	150(150)	200(200)	260(260)	260(260)	350(350)	450(450)	660(660)	900(800)
85	105	125	150	180	250	300	400	630	800
85	105	120	150	180	250	300	400	630	800
75	85	90	140	180	200	250	350	500	720
52	65	70	100	120	150	220	300	420	630
7.5	11	15	18.5	22	22	37	45	65	75
15	18.5	22	30	37	45	60	75	110	130
15	18.5	22	37	45	55	60	90	130	150
15	18.5	22	30	50	55	75	90	130	150
62	75	90	110	150	180	220	300	400	630
80	93	120	150	180	220	300	400	630	800
80	93	100	150	180	220	300	400	630	800
60	70	80	150	180	220	300	300	630	800
60	90	90	130	180	220	280	280	630	630
50	80	80	120	150	150	200	200	630	630
20	50	50	80	100	100	150	150	630	630
35	35	38	50	60	60	95	115	190	190
60	60	65	80	120	120	150	200	350	350
48	60	65	80	150	150	200	250	350	350
50	60	65	80	150	150	200	200	400	400
850/850	1050/1050	1250/1250	1500/1500	1800/1800	2500/2500	3000/3000	4000/4000	6500/6500	8000/8000
800/750	930/930	1000/1000	1200/1200	1450/1450	2000/2000	2400/2400	3200/3200	5040/5040	6400/6400
1,200	1,200	1,200	1,200	1,200	1,200	1,200	1,200	1,200	1,200
1,200	1,200	1,200	1,200	1,200	1,200	1,200	1,200	1,200	1,200
600	300	300	300	300	300	300	300	300	300
27	27	25	27	30	30	35	35	65	65
75	75	85	85	100	100	120	120	75	75
75	75	125	135	—	145	175	175	105	105
18	18	22	37	—	40	55	55	80	80
210	210	270	270	440	440	440	440	790	790
23	23	24	24	40	40	50	50	90	90
2.8	2.8	2.9	2.9	4.2	4.2	6.1	6.1	17	17
24	24	31	31	—	41	55	55	600	600
24	24	31	31	—	41	55	55	72	72
0.85 to 1.1 times rated coil voltage									
5	5	5	5	5	5	5	5	5	5
-25 to +55									
19.6									
49									
2-60	(2-60) ³	(6-70) ³	(6-95) ³	(10-120) ³	(10-150) ³	(25-240) ³	(25-240) ³	(70-325) ³	(70-325) ³
2-50	2-50	(6-70) ³	(6-95) ³	(10-120) ³	(10-150) ³	(25-240) ³	(25-240) ³	—	—
1-2.5	1-2.5	1-2.5	1-2.5	1-2.5	1-2.5	1-2.5	1-2.5	1-4	1-4
15	15	15	20	25	25	30	30	35	35

Rated operating current of auxiliary contacts

Table 1.4.1 (2)

Conventional free air thermal current	A	16
Rated operating current		
Category 120VAC	A	6
AC-15 240VAC	A	5
500VAC	A	3
660VAC	A	1.5
Category 24VDC	A	5
48VDC	A	3
DC-13 110VDC	A	0.6
	A	0.8 ¹
220VDC	A	0.2

Note: 1 UN-AX2(CX), UN-AX4(CX), UN-AX11(CX).

1.4.2 Performance of Series S-N Contactors

Electrical Life

The electrical life of the main contacts of a contactor is determined mainly by the circuit-opening duty it will perform. The relationship between electrical life and rated current of Mitsubishi contactors under normal and jogging duties of squirrel-cage motors is shown in Fig. 1.4.2(1) and 1.4.2(2). In the case of a mixture of normal and jogging duties, the expected contactor life can be determined as follows:

$$N = Nr/1 + \frac{\alpha}{100} (Nr/Ni - 1) \dots\dots\dots \text{Eq.1.1}$$

where N : Life in the case of α% jogging duty
 Nr : Life in the case of normal duty
 Ni : Life in the case of 100% jogging duty
 α : Percentage of jogging duty

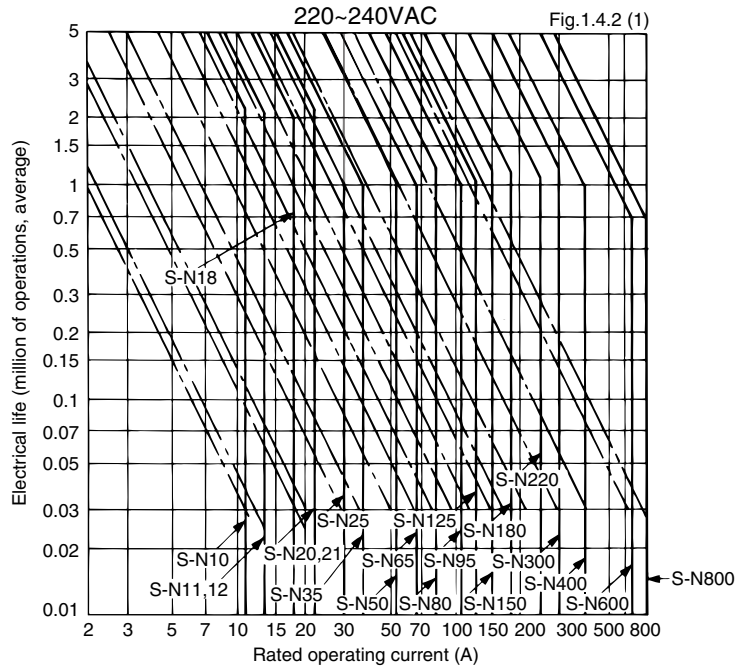

Electrical life versus rated operating current

- Normal duty, 6le on, 6le off, on-load factor 40%, 1200 operations/hour (AC3)
- - - Jogging duty, 6le on, 6le off, on-load factor 7%, 600 operations/hour (AC4)-S-N10~S-N300
 300 operations/hour (AC4)-S-N400~S-N600
 150 operations/hour (AC4)-S-N800

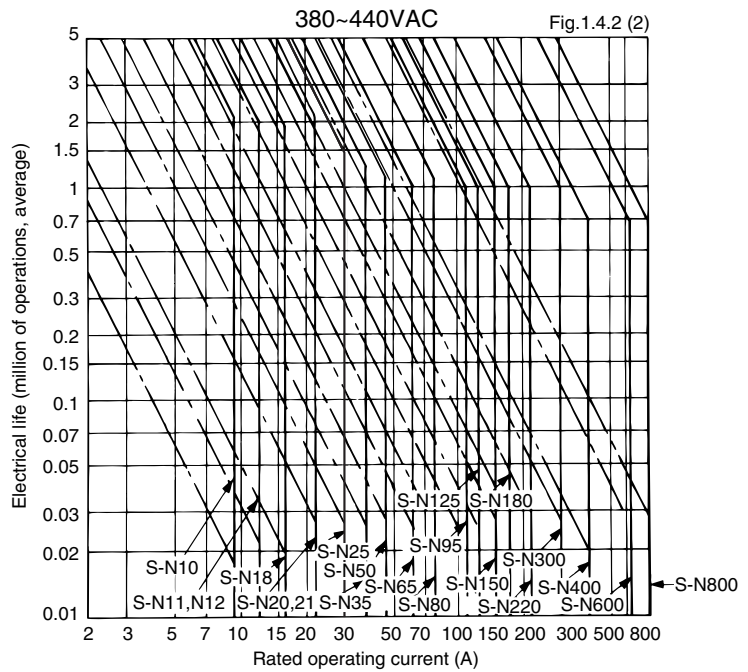

1.4.3 Mounting Attitude of Starters and Contactors

To assure proper performance, Mitsubishi magnetic motor starters and contactors should be mounted on a vertical supporting surface with the line terminals upwards and the load terminals downwards. The supporting surface may have a maximum inclination of 30° from the vertical in any direction.

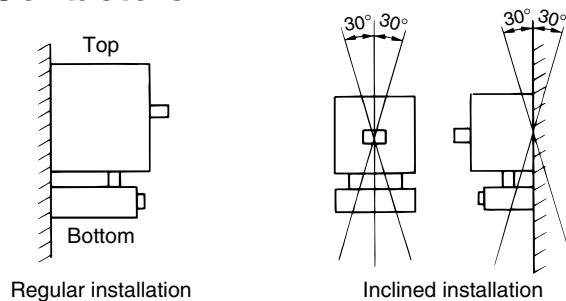

1.5 When Ordering

Contactors, indicate the model name and the ordering designation of the coil.

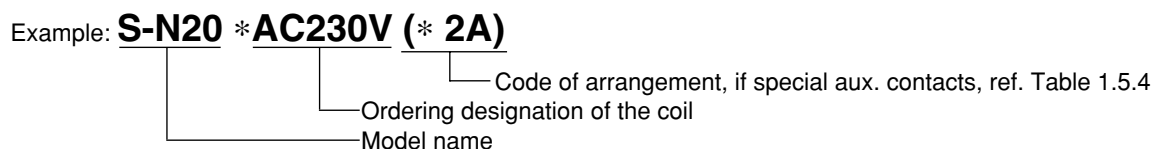

Overload relays, indicate the model name and the ordering designation of the heater setting range.

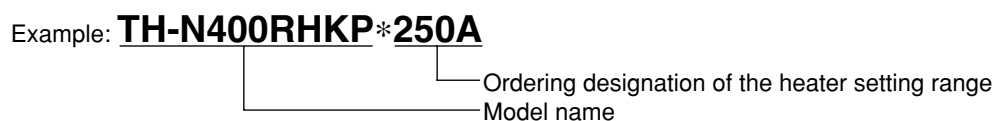

Motor starters, indicate the model name, heater setting range, main circuit voltage, coil designation.

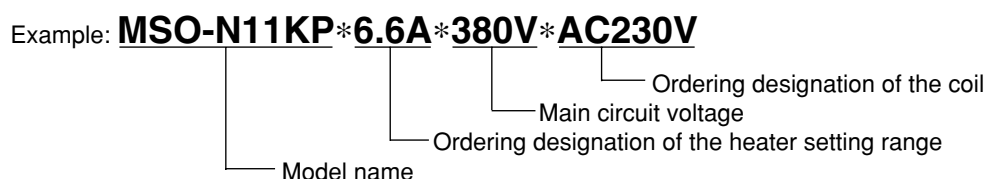

Note: Mark * indicates a blank space.

Coil Ratings and Ordering Designations

for **S-N10(CX), -N11(CX), -N12(CX), -N18(CX), -N20(CX), -N21(CX), -N25(CX), -N35(CX)** and **SR-N(CX)**

Table 1.5.1

Rated voltage (VAC)		Ordering designation
50Hz	60Hz	
24	24	AC24V
48~50	48~50	AC48V
100	100~110	AC100V
110~120	115~120	AC120V
125~127	127	AC127V
200	200~220	AC200V
208~220	220	AC220V
220~240	230~240	AC230V
240~260	260~280	AC260V
346~380	380	AC380V
380~415	400~440	AC400V
415~440	460~480	AC440V
500	500~550	AC500V

for **S-N50(CX)~N800**

Table 1.5.2

Rated voltage (50/60Hz)	Ordering designation
100~127V	AC100V
200~240V	AC200V
260~350V	AC300V
380~440V	AC400V
460~550V	AC500V

AC24V, AC48V are available for S-N50(CX)~N150

for **SD-N, SRD-N**

Table 1.5.3

Rated voltage (VDC)	Ordering designation
24	DC24V
48	DC48V
100	DC100V
110	DC110V
120~125	DC125V
200	DC200V
220	DC220V

Code of arrangement for special aux. Contacts

Table 1.5.4

Arrangement	Code
1NC	1B
2NO	2A

A : Normally Open

B : Normally Closed

1.6 Selection Table of Contactors

1.6.1 Non-Reversing Contactors

Type S-N□, SD-N□

Ordering Designation

Model name S-N10
 Coil designation (See page 13) AC400V
 If required special aux. contact (never specify for standard) 1B
 Complete type designation S-N10*AC400V*1B

Note: Mark*indicates a blank space.

Table 1.6.1

Rated operational current AC-3		Rated motor capacity 3-phase AC-2 & AC-3				Model name		Standard aux. contacts		Finger protection terminal cover	Additional auxiliary contact block					
220V	380V	220V	380V	500V	690V	AC operated	DC operated	NO	NC		UN-AX2(CX)	UN-AX4(CX)	UN-AX11(CX)	UN-AX80	UN-AX150	UN-AX600
(A)	(A)	(kW)	(kW)	(kW)	(kW)											
11	9	2.5	4	4	4	S-N10	—	1	—	—	1	—	—	—	—	—
						S-N10CX ¹	—	—	—	Provided						
						S-N10(1B)	—	—	1	—						
						S-N10CX ¹ (1B)	—	—	—	Provided						
13	12	3.5	5.5	5.5	5.5	S-N11	SD-N11	1	—	—						
						S-N11CX ¹	SD-N11CX ¹	—	—	Provided						
						S-N11(1B)	SD-N11(1B)	—	1	—						
						S-N11CX ¹ (1B)	SD-N11CX ¹ (1B)	—	—	Provided						
13	12	3.5	5.5	5.5	5.5	S-N12	SD-N12	1	1	—						
						S-N12CX ¹	SD-N12CX ¹	—	—	Provided						
						S-N12(2A)	SD-N12(2A)	2	—	—						
						S-N12CX ¹ (2A)	SD-N12CX ¹ (2A)	—	—	Provided						
18	16	4.5	7.5	7.5	7.5	S-N18	—	—	—	—						
						S-N18CX ¹	—	—	—	Provided						
22	22	5.5	11	11	7.5	S-N20	—	1	1	—						
						S-N20CX ¹	—	—	—	Provided						
						S-N20(2A)	—	2	—	—						
						S-N20CX ¹ (2A)	—	—	—	Provided						
22	22	5.5	11	11	7.5	S-N21	SD-N21	2	2	—						
						S-N21CX ¹	SD-N21CX ¹	—	—	Provided						
30	30	7.5	15	15	11	S-N25	—	2	2	—						
						S-N25CX ¹	—	—	—	Provided						
40	40	11	18.5	18.5	15	S-N35	SD-N35	2	2	—						
						S-N35CX ¹	SD-N35CX ¹	—	—	Provided						
55	50	15	22	25	22	S-N50	SD-N50	2	2	—						
						S-N50CX ¹	SD-N50CX ¹	—	—	Provided						
65	65	18.5	30	37	30	S-N65	SD-N65	2	2	—						
						S-N65CX ¹	SD-N65CX ¹	—	—	Provided						
85	85	22	45	45	45	S-N80	SD-N80	2	2	—						
105	105	30	55	55	55	S-N95	SD-N95	2	2	—						
125	120	37	60	60	60	S-N125	SD-N125	2	2	—						
150	150	45	75	90	90	S-N150	SD-N150	2	2	—						
180	180	55	90	110	110	S-N180	—	2	2	—						
250	250	75	132	132	132	S-N220	SD-N220	2	2	—						
300	300	90	160	160	200	S-N300	SD-N300	2	2	—						
400	400	125	220	225	250	S-N400	SD-N400	2	2	—						
630	630	190	330	330	330	S-N600	SD-N600	2	2	—						
800	800	220	440	500	500	S-N800	SD-N800	2	2	—						

Note:1 "CX" denotes with finger protection terminal covers.



S-N10CX



S-N21



SD-N65



S-N220



SD-N400



S-N800

1.6.2 Reversing Contactors

Type S-2xN□,SD-2xN□

Ordering Designation

Model name..... S-2xN95
 Coil designation (See page 13) AC400V
 Complete type designation S-2xN95*AC400V

Note: Mark*indicates a blank space.

Table 1.6.2

Rated operational current AC-3		Rated motor capacity 3-phase AC-2 & AC-3				Model name		Standard aux. contacts		Additional auxiliary contact block(max).				
220 -240V (A)	380 -440V (A)	220 -240V (kW)	380 -440V (kW)	500V (kW)	690V (kW)	AC operated	DC operated	NO	NC	UN- AX2(CX)	UN- AX4(CX)	UN- AX11(CX)	UN- AX80	UN- AX150
11	9	2.5	4	4	4	S-2xN10 S-2xN10CX ¹	—	2	2	2	2	2	—	—
13	12	3.5	5.5	5.5	5.5	S-2xN11 S-2xN11CX ¹	SD-2xN11 SD-2xN11CX ¹	2	2	2	2	2	—	—
18	16	4.5	7.5	7.5	7.5	S-2xN18 S-2xN18CX ¹	—	4	4	—	—	—	—	—
22	22	5.5	11	11	7.5	S-2xN20 S-2xN20CX ¹	—	2	2	—	—	—	—	—
22	22	5.5	11	11	7.5	S-2xN21 S-2xN21CX ¹	SD-2xN21 SD-2xN21CX ¹	4	4	—	—	—	—	—
30	30	7.5	15	15	11	S-2xN25 S-2xN25CX ¹	—	4	4	2	2	2	—	—
40	40	11	18.5	18.5	15	S-2xN35 S-2xN35CX ¹	SD-2xN35 SD-2xN35CX ¹	4	4	—	—	—	—	—
55	50	15	22	25	22	S-2xN50 S-2xN50CX ¹	SD-2xN50	4	4	—	—	—	—	—
65	65	18.5	30	37	30	S-2xN65 S-2xN65CX ¹	SD-2xN65	4	4	—	—	—	—	—
85	85	22	45	45	45	S-2xN80	SD-2xN80	4	4	—	—	—	2	—
105	105	30	55	55	55	S-2xN95	SD-2xN95	4	4	—	—	—	—	—
125	120	37	60	60	60	S-2xN125	SD-2xN125	4	4	—	—	—	—	—
150	150	45	75	90	90	S-2xN150	SD-2xN150	6	6	—	—	—	—	—
180	180	55	90	110	110	S-2xN180	—	6	6	—	—	—	—	—
250	250	75	132	132	132	S-2xN220	SD-2xN220	6	6	—	—	—	—	2
300	300	90	160	160	200	S-2xN300	SD-2xN300	6	6	—	—	—	—	—
400	400	125	220	225	250	S-2xN400	SD-2xN400	6	6	—	—	—	—	—
630	630	190	330	330	330	S-2xN600	SD-2xN600	8	8	—	—	—	—	—
800	800	220	440	500	500	S-2xN800	SD-2xN800	8	8	—	—	—	—	—

Note:1 "CX" denotes with finger protection terminal covers.



S-2xN11

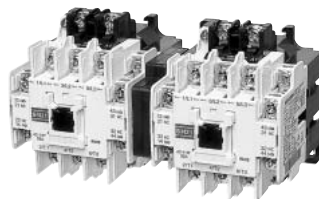

S-2xN21



S-2xN150

1.6.3 Non-Reversing Mechanically Latched Contactors



Type SL-N□, SLD-N□

Ordering Designation

Model name SL-N35
 Closing coil designation¹ AC200V
 Tripping coil designation¹ DC100V
 Complete type designation SL-N35*MC-AC200V*MT-DC100V

Note: Mark*indicates a blank space.
 1. See Table 1.6.3 (2).

Table 1.6.3 (1)

Rated operational current AC-3		Rated motor capacity 3-phase AC-2 & AC-3				Model name		Standard free aux. contacts	Additional auxiliary contact block				
220 -240V (A)	380 -440V (A)	220 -240V (kW)	380 -440V (kW)	500V (kW)	690V (kW)	AC operated (closing coil)	DC operated (closing coil)			UN-AX11	UN-AX80	UN-AX150	UN-AX600
22	22	5.5	11	11	7.5	SL-N21	SLD-N21	2	2	Max.2	—	—	—
40	40	11	18.5	18.5	15	SL-N35	SLD-N35	2	2				
55	50	15	22	25	22	SL-N50	SLD-N50	2	2				
65	65	18.5	30	37	30	SL-N65	SLD-N65	2	2				
85	85	22	45	45	45	SL-N80	SLD-N80	1	2	—	Max.2	—	—
105	105	30	55	55	55	SL-N95	SLD-N95	1	2				
125	120	37	60	60	60	SL-N125	SLD-N125	1	2	—	—	Max.2	—
150	150	45	75	90	90	SL-N150	SLD-N150	1	2				
250	250	75	132	132	132	SL-N220	SLD-N220	1	2				
300	300	90	160	160	200	SL-N300	SLD-N300	1	2				
400	400	125	220	225	250	SL-N400	SLD-N400	1	2	—	—	—	1
630	630	190	330	330	330	SL-N600	SLD-N600	1	2				
800	800	220	440	500	500	SL-N800	SLD-N800	1	2				

• Coil Ratings (Closing & Tripping)

Table 1.6.3 (2)

Ordering designation	Applicable voltage
AC100V	100-127VAC 50/60Hz
AC200V	200-240VAC 50/60Hz
AC300V	260-350VAC 50/60Hz
AC400V	380-440VAC 50/60Hz
AC500V	460-550VAC 50/60Hz
DC24V	24VDC
DC48V	48VDC
DC100V	100-110VDC
DC125V	120-125VDC
DC200V	200-220VDC

• Precautions

- Minimum energising time, both for closing and tripping must be set longer than the followings.
 SL(D)-N21 to N220 : 0.3 sec.
 SL(D)-N300 to N800 : 0.5 sec.
- Make sure never to over lap the energising time for closing and tripping.

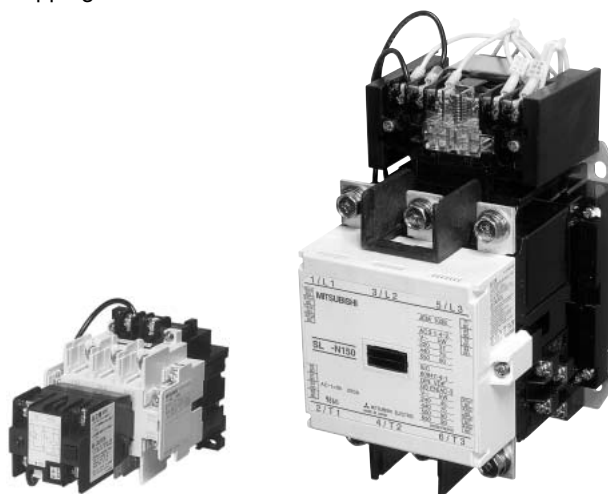

SL-N35

SL-N150

1.6.4 Reversing Mechanically Latched Contactors

(Components for Automatic Transfer Switches)

Type **SL-2xN□**, **SLD-2xN□**, **SLxS-N□**

Ordering Designation

• Mechanically latched & mechanically latched contactor	
Model name	SL-2xN35
Closing coil designation in normal left side ¹	AC200V
Tripping coil designation in normal left side ¹	DC100V
Closing coil designation in standby right side ¹	DC100V
Tripping coil designation in standby right side ¹	AC200V
Complete type designation	SL-2xN35*MC1-AC200V*MT1-DC100V*MC2-DC100V*MT2-AC200V
• Mechanically latched & normal contactor	
Model name	SLxS-N150
Closing coil designation in normal left side ¹	AC200V
Tripping coil designation in normal left side ¹	AC100V
Coil designation in standby right side ²	AC100V
Complete type designation	SLxS-N150*MC1-AC200V*MT1-AC100V*AC100V

Notes: Mark*indicates a blank space.

1. See Table 1.6.3(2) 2. See Table 1.5.2

Table 1.6.4

Rated operational current AC-3		Rated motor capacity 3-phase AC-2 & AC-3				Model name mechanically latched & mechanically latched			Mechanically latched & normal			Additional auxiliary contact block		
220	380	220	380			AC operated	DC operated	AC operated	UN-AX11	UA-AX80	UA-AX150			
-240V	-440V	-240V	-440V	500V	690V	(closing coil)	(closing coil)	(closing coil)						
(A)	(A)	(kW)	(kW)	(kW)	(kW)									
22	22	5.5	11	11	7.5	SL-2xN21	SLD-2xN21	—	Max.2	—	—			
40	40	11	18.5	18.5	15	SL-2xN35	SLD-2xN35	—						
55	50	15	22	25	22	SL-2xN50	SLD-2xN50	—						
65	65	18.5	30	37	30	SL-2xN65	SLD-2xN65	SLxS-N65						
85	85	22	45	45	45	SL-2xN80	SLD-2xN80	—	—	Max.2	—			
105	105	30	55	55	55	SL-2xN95	SLD-2xN95	—						
125	120	37	60	60	60	SL-2xN125	SLD-2xN125	SLxS-N125						
150	150	45	75	90	90	SL-2xN150	SLD-2xN150	SLxS-N150	—	—	Max.2			
250	250	75	132	132	132	SL-2xN220	SLD-2xN220	SLxS-N220						
300	300	90	160	160	200	SL-2xN300	SLD-2xN300	SLxS-N300						
400	400	125	220	225	250	SL-2xN400	SLD-2xN400	SLxS-N400						
630	630	190	330	330	330	SL-2xN600	SLD-2xN600	—	—	—	—			
800	800	220	440	500	500	SL-2xN800	SLD-2xN800	—						

• Precautions

- Minimum energising time both for closing and tripping must be set longer than the followings.

SL(D)-2xN21 to N220, SLxS-N65 to N220 : 0.3 sec.

SL(D)-2xN300 to N800, SLxS-N300 and N400 : 0.5 sec.

Make sure never to overlap the energising time for closing and tripping.



SL-2xN35

1.7 Selection Table of Direct-On-Line Motor Starters

1.7.1 Non-Reversing Motor Starters without Enclosure (IP 00)

Type MSO-N□

Ordering Designation

Model name MSO-N50KP
 Heater designation of overload relay 42A
 Main circuit voltage 440V
 Coil designation (See page 13) AC200V
 Complete type designation MSO-N50KP*42A*440V*AC200V

Note: Mark*indicates a blank space.

Table 1.7.1

Rated operational current AC-3		Rated motor capacity 3-phase AC-2 & AC-3				Model name		Aux. contacts	Heater designation of overload relay
220 -240V (A)	380 -440V (A)	220 -240V (kW)	380 -440V (kW)	500V (kW)	690V (kW)	Phase failure protection type	Two heater type	(ordering designation)	
11	9	2.5	4	4	4	MSO-N10KP MSO-N10CXKP ¹	MSO-N10	1 —	0.12A, 0.17A, 0.24A, 0.35A, 0.5A, 0.7A 0.9A, 1.3A, 1.7A, 2.1A, 2.5A, 3.6A, 5A 6.6A, 9A
13	12	3.5	5.5	5.5	5.5	MSO-N11KP MSO-N11CXKP ¹	MSO-N11	1 —	
13	12	3.5	5.5	5.5	5.5	MSO-N12KP MSO-N12CXKP ¹	MSO-N12	1 1	15A
18	16	4.5	7.5	7.5	7.5	MSO-N18KP MSO-N18CXKP ¹	MSO-N18	— —	19A
22	22	5.5	11	11	7.5	MSO-N20KP MSO-N20CXKP ¹	MSO-N20	1 1	0.24A, 0.35, 0.5A, 0.7A, 0.9A, 1.3A, 1.7A, 2.1A, 2.5A, 3.6A, 5A, 6.6A, 9A, 11A, 15A
22	22	5.5	11	11	7.5	MSO-N21KP MSO-N21CXKP ¹	MSO-N21	2 2	
30	30	7.5	15	15	11	MSO-N25KP MSO-N25CXKP ¹	MSO-N25	2 2	15A, 22A, 29A, 35A, 42A, 54A
40	40	11	18.5	18.5	15	MSO-N35KP MSO-N35CXKP ¹	MSO-N35	2 2	
55	50	15	22	25	22	MSO-N50KP MSO-N50CXKP ¹	MSO-N50	2 2	42A, 54A, 67A, 82A, 105A
65	65	18.5	30	37	30	MSO-N65KP MSO-N65CXKP ¹	MSO-N65	2 2	
85	85	22	45	45	45	MSO-N80KP	MSO-N80	2 2	82A, 105A, 125A, 150A
105	105	30	55	55	55	MSO-N95KP	MSO-N95	2 2	
125	120	37	60	60	60	MSO-N125KP	MSO-N125	2 2	105A, 125A, 150A, 180A, 250A
150	150	45	75	90	90	MSO-N150KP	MSO-N150	2 2	
180	180	55	90	110	110	MSO-N180KP	MSO-N180	2 2	
250	250	75	132	132	132	MSO-N220KP	MSO-N220	2 2	
300	300	90	160	160	200	MSO-N300KP	MSO-N300	2 2	
400	400	125	220	225	250	MSO-N400KP	MSO-N400	2 2	

Note: 1. "CX" denotes with finger protection terminal covers.



MSO-N11CXKP



MSO-N18KP



MSO-N50



MSO-N125KP



MSO-N220

1.7.2 Reversing Motor Starters without Enclosure (IP 00)

Type MSO-2xN□

Ordering Designation

Model name MSO-2xN35KP
 Heater designation of overload relay 29A
 Main circuit voltage 440V
 Coil designation (See page 13) AC200V

Complete type designation MSO-2xN35KP*29A*440V*AC200V

Note: Mark*indicates a blank space.

Table 1.7.2

Rated operational current AC-3		Rated motor capacity 3-phase AC-2 & AC-3				Model name		Free aux. contacts	Heater designation of overload relay	
220 -240V (A)	380 -440V (A)	220 -240V (kW)	380 -440V (kW)	500V (kW)	690V (kW)	Phase failure protection type	Two heater type		(ordering designation)	
11	9	2.5	4	4	4	MSO-2xN10KP MSO-2xN10CXKP ¹	MSO-2xN10		2 —	0.12A, 0.17A, 0.24A, 0.35A, 0.5A, 0.7A
13	12	3.5	5.5	5.5	5.5	MSO-2xN11KP MSO-2xN11CXKP ¹	MSO-2xN11	2 —	0.9A, 1.3A, 1.7A, 2.1A, 2.5A, 3.6A, 5A	
18	16	4.5	7.5	7.5	7.5	MSO-2xN18KP MSO-2xN18CXKP ¹	MSO-2xN18	4 2	6.6A, 9A, 11A	15A
22	22	5.5	11	11	7.5	MSO-2xN20KP MSO-2xN20CXKP ¹	MSO-2xN20	2 —	0.24A, 0.35A, 0.5A, 0.7A, 0.9A, 1.3A, 1.7A, 2.1A, 2.5A, 3.6A, 5A, 6.6A, 9A, 11A, 15A	19A
22	22	5.5	11	11	7.5	MSO-2xN21KP MSO-2xN21CXKP ¹	MSO-2xN21	4 2		22A
30	30	7.5	15	15	11	MSO-2xN25KP MSO-2xN25CXKP ¹	MSO-2xN25	4 2	9A, 11A, 15A	29A
40	40	11	18.5	18.5	15	MSO-2xN35KP MSO-2xN35CXKP ¹	MSO-2xN35	4 2		35A
55	50	15	22	25	22	MSO-2xN50KP MSO-2xN50CXKP ¹	MSO-2xN50	4 2	15A, 22A, 29A, 35A, 42A, 54A	67A
65	65	18.5	30	37	30	MSO-2xN65KP MSO-2xN65CXKP ¹	MSO-2xN65	4 2		82A
85	85	22	45	45	45	MSO-2xN80KP	MSO-2xN80	4 2	42A, 54A, 67A, 82A, 105A	95A
105	105	30	55	55	55	MSO-2xN95KP	MSO-2xN95	4 2		125A
125	120	37	60	60	60	MSO-2xN125KP	MSO-2xN125	4 2	82A, 105A, 125A, 150A	180A, 210A
150	150	45	75	90	90	MSO-2xN150KP	MSO-2xN150	6 4		330A
180	180	55	90	110	110	MSO-2xN180KP	MSO-2xN180	6 4		
250	250	75	132	132	132	MSO-2xN220KP	MSO-2xN220	6 4		
300	300	90	160	160	200	MSO-2xN300KP	MSO-2xN300	6 4		
400	400	125	220	225	250	MSO-2xN400KP	MSO-2xN400	6 4		

Note: 1. "CX" denotes with finger protection terminal covers.



MSO-2xN11KP



MSO-2xN18

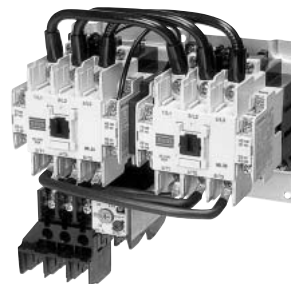

MSO-2xN35



MSO-2xN150KP

1.7.3 Enclosed Non-Reversing Motor Starters (IP 20)

Type MS-N□

Ordering Designation

Model name MS-N21KP
 Heater designation of overload relay 15A
 Main circuit voltage 220V
 Control circuit voltage and frequency 220V 50Hz

Complete type designation MS-N21KP*15A*220V*220V 50Hz

*Note: Mark*indicates a blank space.*

Table 1.7.3

Rated operational current AC-3		Rated motor capacity 3-phase AC-2 & AC-3				Model name		Free aux. contacts	Heater designation of overload relay
220 -240V (A)	380 -440V (A)	220 -240V (kW)	380 -440V (kW)	500V (kW)	690V (kW)	Phase failure protection type	Two heater type	(ordering designation)	
11	9	2.5	4	4	4	MS-N10KP	MS-N10	0.24A, 0.35A, 0.5A, 0.7A, 0.9A, 1.3A	
13	12	3.5	5.5	5.5	5.5	MS-N11KP	MS-N11	1.7A, 2.1A, 2.5A, 3.6A, 5A, 6.6A, 9A	
13	12	3.5	5.5	5.5	5.5	MS-N12KP	MS-N12	11A	
22	22	5.5	11	11	7.5	MS-N20KP	MS-N20	19A	
22	22	5.5	11	11	7.5	MS-N21KP	MS-N21	0.24A, 0.35A, 0.5A, 0.7A, 0.9A, 1.3A, 1.7A, 2.1A, 2.5A, 3.6A, 5A, 6.6A, 9A, 11A, 15A	
30	30	7.5	15	15	11	MS-N25KP	MS-N25	22A	
40	40	11	18.5	18.5	15	MS-N35KP	MS-N35	29A	
55	50	15	22	25	22	MS-N50KP	MS-N50	35A	
65	65	18.5	30	37	30	MS-N65KP	MS-N65	15A, 22A, 29A, 35A, 42A, 54A	
85	85	22	45	45	45	MS-N80KP	MS-N80	67A	
105	105	30	55	55	55	MS-N95KP	MS-N95	82A	
125	120	37	60	60	60	MS-N125KP	MS-N125	95A	
150	150	45	75	90	90	MS-N150KP	MS-N150	42A, 54A, 67A, 82A, 105A	
180	180	55	90	110	110	MS-N180KP	MS-N180	125A	
250	250	75	132	132	132	MS-N220KP	MS-N220	82A, 105A, 125A, 150A	
300	300	90	160	160	200	MS-N300KP	MS-N300	180A, 210A	
400	400	125	220	225	250	MS-N400KP	MS-N400	105A, 125A, 150A, 180A, 250A	
								330A	

Note: 1. Models with finger protection terminal covers are not available.



MS-N10



MS-N21



MS-N65



MS-N220KP

1.7.4 Enclosed Non-Reversing Motor Starters with Pushbutton Switch (IP 20)

Type **MS-N□PM**

When the thermal overload relay is tripped, type MS-N□PM enclosed direct-on-line motor starters can be easily reset by pushing the OFF button on the enclosure (MS-N10 KPPM and -N11 KPPM can be reset by pushing the RESET button).

Ordering Designation

Model name MS-N21KPPM
 Heater designation of overload relay 15A
 Main circuit voltage 220V
 Control circuit voltage and frequency 220V 50Hz

*Note: Mark*indicates a blank space.*

Complete type designation **MS-N21KPPM*15A*220V*220V 50Hz**

Table 1.7.4

Rated operational current AC-3		Rated motor capacity 3-phase AC-2 & AC-3				Model name		Free aux. contacts		Heater designation of overload relay	
220 -240V (A)	380 -440V (A)	220 -240V (kW)	380 -440V (kW)	500V (kW)	690V (kW)	Phase failure protection type	Two heater type	1	2	(ordering designation)	
11	9	2.5	4	4	4	MS-N10KPPM	MS-N10PM	1	—	0.24A, 0.35A, 0.5A, 0.7A, 0.9A, 1.3A, 1.7A, 2.1A, 2.5A, 3.6A, 5A, 6.6A, 9A	
13	12	3.5	5.5	5.5	5.5	MS-N11KPPM	MS-N11PM	1	—	11A	
22	22	5.5	11	11	7.5	MS-N20KPPM	MS-N20PM	—	1	19A	
22	22	5.5	11	11	7.5	MS-N21KPPM	MS-N21PM	1	2	0.24A, 0.35A, 0.5A, 0.7A, 0.9A, 1.3A, 1.7A, 2.1A, 2.5A, 3.6A, 5A, 6.6A, 9A, 11A, 15A	
30	30	7.5	15	15	11	MS-N25KPPM	MS-N25PM	1	2	22A	
40	40	11	18.5	18.5	15	MS-N35KPPM	MS-N35PM	1	2	29A 35A	
55	50	15	22	25	22	MS-N50KPPM	MS-N50PM	1	2		
65	65	18.5	30	37	30	MS-N65KPPM	MS-N65PM	1	2	15A, 22A, 29A, 35A, 42A, 54A	
85	85	22	45	45	45	MS-N80KPPM	MS-N80PM	1	2	67A	
105	105	30	55	55	55	MS-N95KPPM	MS-N95PM	1	2	82A 95A	



MS-N11PM



MS-N80PMKP

1.8 Optional Parts and Accessories for Contactors

1.8.1 Replacement Coils

Table 1.8.1

AC operated coils				DC operated coils			
Contactors(s)	Part number*		Mass(kg)	Contactors(s)	Part number*		Mass(kg)
S-N10, S-N11, S-N12,	S-N10-COIL	AC □□□V	0.06	SD-N11, SD-N12,	SD-N11-COIL	DC □□□V	0.23
S-N18, SR-N4	SR-N4-COIL	AC □□□V		SRD-N4			
S-N20, S-N21	S-N21-COIL	AC □□□V	0.08	SD-N21	SD-N21-COIL	DC □□□V	0.24
S-N25, S-N35	S-N35-COIL	AC □□□V	0.08	SD-N35	SD-N35-COIL	DC □□□V	0.23
S-N50, S-N65	S-N50-COIL	AC □□□V	0.27	SD-N50, SD-N65	SD-N50-COIL	DC □□□V	0.8
S-N80, S-N95	S-N80-COIL	AC □□□V	0.6	SD-N80, SD-N95	SD-N80-COIL	DC □□□V	0.6
S-N125, S-N150	S-N125-COIL	AC □□□V	0.46	SD-N125, SD-N150	SD-N125-COIL	DC □□□V	0.9
S-N180, S-N220	S-N180-COIL	AC □□□V	0.6	SD-N220	SD-N220-COIL	DC □□□V	1.4
S-N300, S-N400	S-N300-COIL	AC □□□V	0.9	SD-N300, SD-N400	SD-N300-COIL	DC □□□V	2.0
S-N600, S-N800	S-N600-COIL	AC □□□V	2.0	SD-N600, SD-N800	SD-N600-COIL	DC □□□V	6.0

Note: When ordering, please specify the operating voltage according to Table 1.5.1~3.

1.8.2 Replacement Contact Kits

Table 1.8.2 (1)







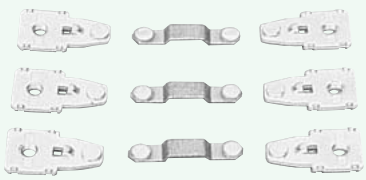

Kits of main contacts for contactors	Contactor	Part number	Mass(kg)
 <p>PARTS BH739N300</p>	Kit consists of 3 moving contacts and 6 stationary contacts (include springs and spring supports also).	S-N10(CX)*, -N11(CX), -N12(CX) SD-N11(CX), -N12(CX)	PARTS BH719N300 0.03
		S-N18(CX) S-N20(CX), -N21(CX), SD-N21(CX) S-N25(CX) S-N35(CX) SD-N35(CX) S-N50(CX) SD-N50 S-N65(CX) SD-N65 S-N80 SD-N80 S-N95 SD-N95 S-N125 SD-N125 S(D)-N150 S-N180 S(D)-N220 S(D)-N300 S(D)-N400 S(D)-N600 S(D)-N800	PARTS BH729N300 0.05 PARTS BH739N300 0.05 PARTS BH749N300 0.07 PARTS BH749N301 0.07 PARTS BH749N303 0.07 PARTS BH759N300 0.11 PARTS BH759N302 0.11 PARTS BH759N301 0.11 PARTS BH759N303 0.11 PARTS BH769N300 0.1 PARTS BH769N302 0.1 PARTS BH769N301 0.1 PARTS BH769N303 0.1 PARTS BH779N300 0.1 PARTS BH779N301 0.1 PARTS BH789N300 0.2 PARTS BH799N300 0.4 PARTS BH799N301 0.4 PARTS BH609N300 0.8 PARTS BH609N301 0.8 PARTS BH619N300 2.5 PARTS BH619N301 2.5
 <p>BH769N300</p>			
 <p>B799N300</p>			

Table 1.8.2 (2)

Kits of auxiliary contacts for contactors	Contactor	For arrangement	Part number	Mass(kg)	
 <p>PARTS BH719N310</p>	Kit consists of 1 bifurcated moving contact and 2 stationary contacts.	1NO	PARTS BH719N310	0.01	
		1NC	PARTS BH719N311	0.01	
 <p>PARTS BH729N310</p>	Kit consists of 2 bifurcated moving contacts and 4 stationary contacts.	1NO+1NC	PARTS BH729N310	0.01	
		1NO+1NC	PARTS BH739N310	0.02	
 <p>PARTS BH739N311</p>	Kit consists of 4 bifurcated moving contacts and 8 stationary contacts.	S-N21(CX) to S-N35(CX),	PARTS BH739N311	0.03	
		SD-N21(CX) to SD-N35(CX),			
		S-N50(CX) to N95	2NO+2NC	PARTS BH539N315	0.02
		SD-N50 to N95	2NO+2NC	PARTS BH579N312	0.02
	S-N125, SD-N125	2NO+2NC	PARTS BH579N312	0.02	
	S-N150 to N800	(Use auxiliary contact blocks, see 1.8.3 "Auxiliary Contact Blocks.")			
	SD-N150 to N800				

1.8.3 Auxiliary Contact Blocks

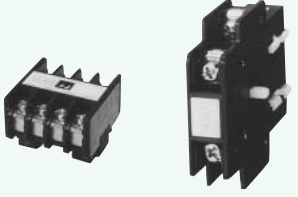
Table 1.8.3

	Mounting	Contactor/Relay	Type for	Contact arrangement	Part Number				
 <p>UN-AX4 UN-AX11</p>	Front clip-on ^{1,2}	S-N10(CX), -N11(CX), -N12(CX), -N20(CX), -N21(CX), -N25(CX), -N35(CX), -N18(CX), -N28(CX), -N38(CX), -N48(CX), -N50(CX), -N65(CX) SD-N11(CX), -N12(CX), -N21(CX), -N35(CX), -N50, -N65 SR-N4(CX) SRD-N4(CX)	Standard	2NO	UN-AX2(CX)2A				
				1NO+1NC	UN-AX2(CX)1A1B				
				2NC	UN-AX2(CX)2B				
				4NO	UN-AX4(CX)4A				
				3NO+1NC	UN-AX4(CX)3A1B				
				2NO+2NC	UN-AX4(CX)2A2B				
				Low level signal (5Vdc 5mA)	1NO+1NC (low level)	UN-LL22(CX)			
					1NO+1NC (standard)				
				 <p>UN-AX150</p>	Side clip-on ^{1,3}	S-N10(CX), -N11(CX), -N20(CX), -N21(CX), -N25(CX), -N35(CX) -N50(CX), -N65(CX) SD-N11(CX), -N21(CX), -N35(CX) -N50, -N65 SR-N4(CX), SRD-N4(CX)	Standard	1NO+1NC	UN-AX11(CX)
								Side clip-on ³	S(D)-N80, -N95, -N125
S(D)-N150, -N220, -N300, -N400, S-N180	1NO+1NC	UN-AX150							
S(D)-N600, -N800	2NO+2NC	UN-AX600							

Notes: 1 Front clip-on and side clip-on should not be mounted both.

2 Maximum 1 piece of aux. contact block can be mounted on a Contactor / Relay.

3 Maximum 2 pieces of aux. contact block can be mounted on a Contactor / Relay.

1.8.4 Mechanical Interlocks

Table 1.8.4

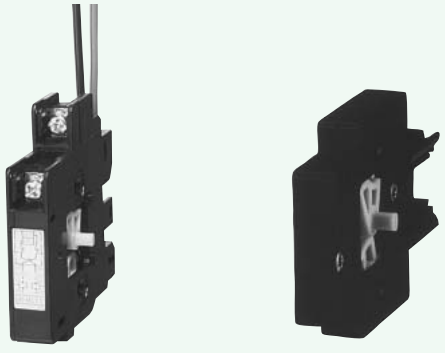
	Contactor	Part Number
 <p>UN-ML11 UN-ML21</p>	S-N10(CX), -N11(CX), SD-N11(CX)	UN-ML11(CX)
	S-N20(CX), -N21(CX), -N25(CX), -N35(CX), -N18(CX), -N28(CX), -N38(CX), -N48(CX), -N50(CX), -N65(CX)	UN-ML21
	SD-N21(CX), -N35(CX), -N50, -N65	
	S(D)-N80, -N95, -N125	UN-ML80
	S(D)-N150	UN-ML150
	S-N180, S(D)-N220, -N300, -N400	UN-ML220

1.8.5 Connecting Bar Kits

Table 1.8.5

	For connecting reversing contactors	Contactor	Part Number
 <p>UN-SD50</p>	Kit consists of 3 connecting bars or wires each for source and load side.	S-2×N10(CX), -2×N11(CX)	UN-SD10CX
		S-2×N18	UN-SD18CX
		S-2×N18CX	UN-SD18CX
		S-2×N20, -2×N21	UN-SD21CX
		S-2×N20CX, N2×N21CX	UN-SD21CX
		S-2×N25, -2×N35	UN-SD35CX
		S-2×N25CX, -2×N35CX	UN-SD35CX
		S-2×N50(CX), -2×N65(CX)	UN-SD50
		S-2×N80, -2×N95	UN-SD80
		S-2×N125	UN-SD125
		S-2×N150	UN-SD150
		S-2×N180, -2×N220	UN-SD220
		S-2×N300, -2×N400	UN-SD300
		S-2×N600, -2×N800	UN-SD600

1.8.6 Surge Absorbers

Table 1.8.6

	Contactor/Relay	Applicable control voltage	Part Number	
 <p>UN-SA13</p>	Varistor type	S-N10, -N11, -N12, -N18, -N20, -N21, -N25, -N35, -N28, -N38, -N48 SD-N11, -N12, -N21, -N35, SR(D)-N4	AC24-240V/DC24-250V AC200-480V	UN-SA21 AC200V UN-SA21 AC400V
	Varistor type with operating indicator (LED)	S-N10, -N11, -N12, -N18, -N20, -N21, -N25, -N35, -N28, -N38, -N48 SD-N11, -N12, -N21, -N35, SR(D)-N4	AC50-240V DC60-250V	UN-SA22 AC200V
	Varistor and CR type	S-N10, -N11, -N18, -N20, -N21, -N25, -N35, -N28, -N38, -N48 SD-N11, -N12, -N21, -N35 SR(D)-N4	AC24-50V DC24-60V AC100-240V DC100-250V	UN-SA25 AC48V UN-SA25 AC200V
CR type	S-N10, -N11, -N12, -N18, -N20, -N21, -N25, -N35, -N28, -N38, -N48, SR-N4 SD-N11, -N12, -N21, -N35, SRD-N4	AC24-240V DC24-250V	UN-SA23 AC200V UN-SA13 DC200V	

1.8.7 Terminal Covers

Table 1.8.7

For contactors	Contactor	Part Number	For starters	Starter (loadside)	Part Number
 <p>S-N50 with 2pcs of UN-CZ500</p>	S(D)-N50, -N65 ³	UN-CZ500¹		MSO(D)-N50, -N65 ³	UN-CZ501² (+CZ500)
	S(D)-N80, -N95	UN-CZ800¹		MSO(D)-N80, -N95	UN-CZ801² (+CZ800)
	S(D)-N125	UN-CZ1250¹		MSO(D)-N125	UN-CZ1251² (+CZ1250)
	S(D)-N150	UN-CZ1500¹		MSO(D)-N150	UN-CZ1501² (+CZ1500)
	S-N180, S(D)-N220	UN-CZ2200¹		MSO-N180, MSO(D)-N220	UN-CZ2201² (+CZ2200)
	S(D)-N300, -N400	UN-CZ3000¹		MSO(D)-N300, -N400	UN-CZ3001² (+CZ3000)
	S(D)-2×N50, N65	UN-CZ502		MSO(D)-2×N50, N65	UN-CZ504
	S(D)-2×N80, N95	UN-CZ802		MSO(D)-2×N80, N95	UN-CZ804
	S(D)-2×N125	UN-CZ1252		MSO(D)-2×N125	UN-CZ1254
	S(D)-2×N150	UN-CZ1502		MSO(D)-2×N150	UN-CZ1504
	S-2×N180, S(D)-2×N220	UN-CZ2202		MSO-2×N180, MSO(D)-2×N220	UN-CZ2204
	S(D)-2×N300, N400	UN-CZ3002		MSO(D)-2×N300, N400	UN-CZ3004

Notes : 1. 2pcs are required for one contactor

2. For line side another cover (for contactor) is required.

3. Terminal covers should not be mounted for type S-N50CX, S-N65CX, MSO-N50(KP)CX and MSO-N65(KP)CX.

1.8.8 Pneumatic Time Delay Modules

Table 1.8.8

Contactor/Relay	On delay
S-N10(CX)	UN-TR4AN(CX)
S-N11(CX)	
S-N12(CX)	
S-N18(CX)	
SR-N4(CX)	
SD-N11(CX)	
SD-N12(CX)	
SRD-N4(CX)	

For detail see item 4.6.

Note : UN-AX11(CX) (Table 1.8.3) can not be combined to a Contactor / Relay together with UN-TR4AN (CX).

1.8.9 DC Interface Modules

Table 1.8.9

Direct mounting to contactor	Contactor/Relay	Solid state	Relay
 <p>UN-SY21</p>	S-N10(CX), -N11(CX), -N12(CX), -N18(CX), -N20(CX), -N21(CX), -N25(CX), -N35(CX), -N28(CX), -N38(CX), -N48(CX) SR-N4(CX)	UN-SY21(CX)	UN-SY22(CX)
	S-N50 S-N65	UN-SY31	UN-SY32
	S-N80 to N400	UN-SY11	UN-SY12

For detail see item 3.8.

1.9 Connections and Contact Arrangement

1.9.1 S, SD-N □

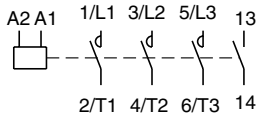

**S-N10, N11(1NO)
SD-N11(1NO)**

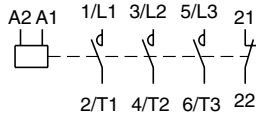

**S-N10, N11(1NC)
SD-N11(1NC)**

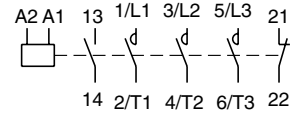

**S-N12, N20
SD-N12**

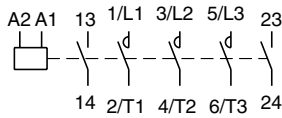

**S-N12(2NO)
S-N20(2NO)**

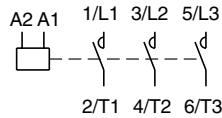

S-N18

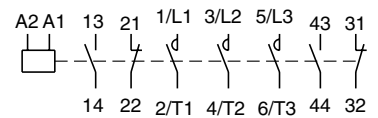

**S-N21, N25, N35
SD-N21, N35**

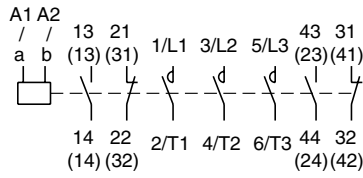

**S-N50~N400
SD-N50~N400**

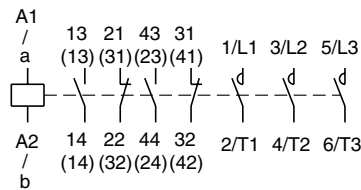

S-N600, N800

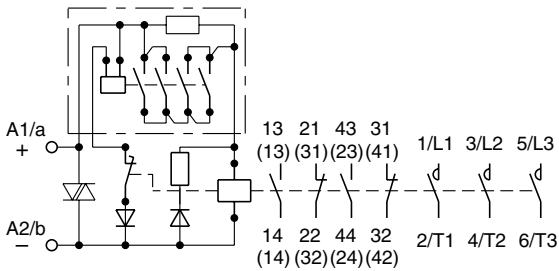

SD-N600, N800

1.9.2 S, SD-2xN □

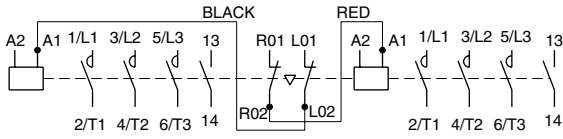

**S-2xN10, N11
SD-2xN11**

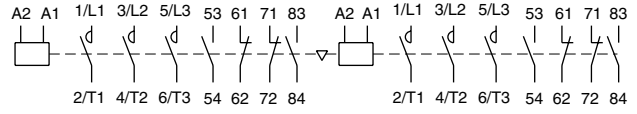

S-2xN18

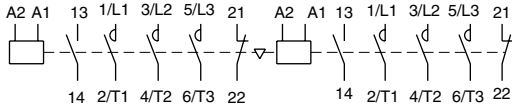

S-2xN20

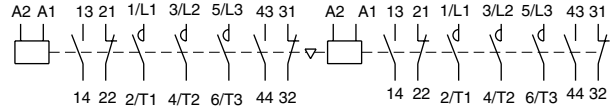

**S-2xN21~N35
SD-2xN21, N35**

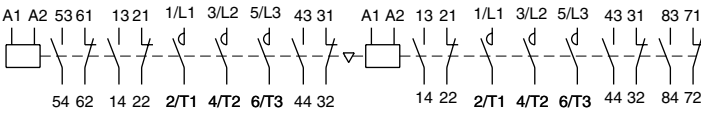

**S-2xN50~N400
SD-2xN50~N150, N220~N400**

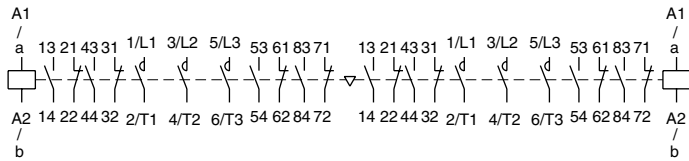

S-2xN600, N800

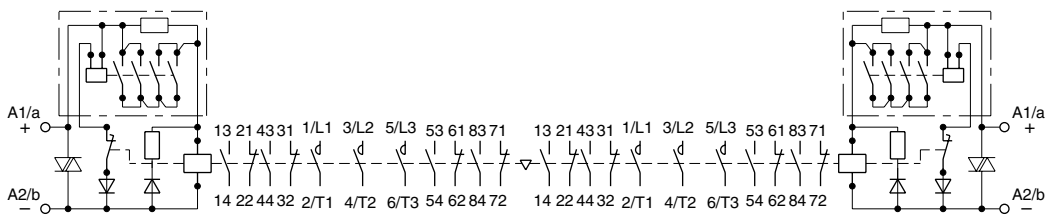

SD-2xN600, N800

1.9.3 SL, SLD-(2x)N □

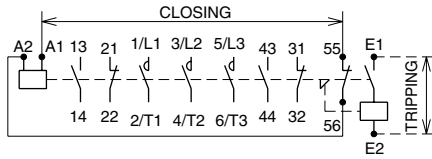

SL(D)-N21, N35

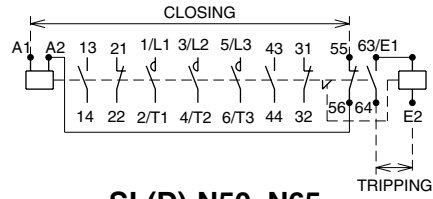

SL(D)-N50, N65

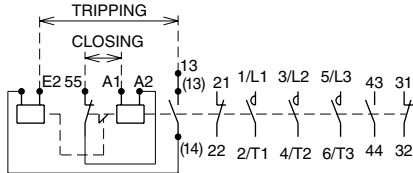

SL(D)-N80~N400

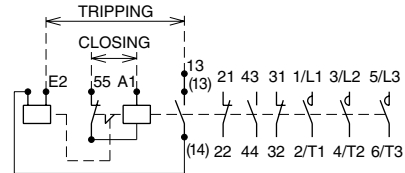

SL(D)-N600, N800

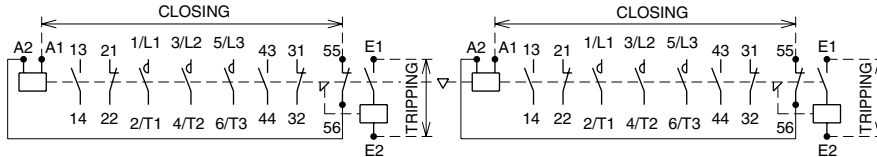

SL(D)-2xN21, N35

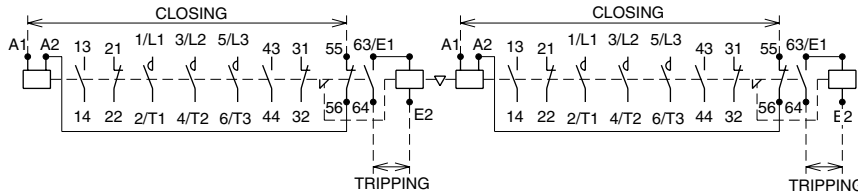

SL(D)-2xN50, N65

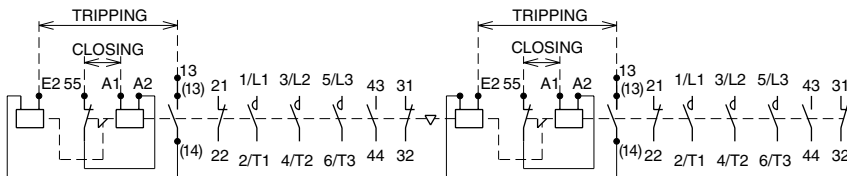

SL(D)-2xN80~N400

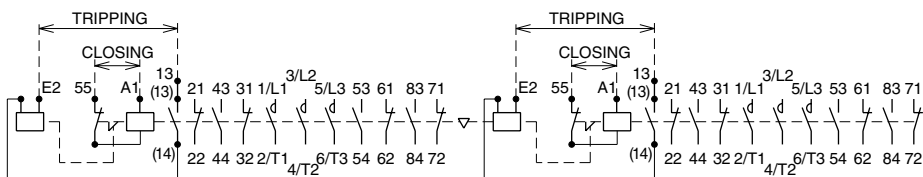

SL(D)-2xN600, N800

1.9.4 MSO-(2x)N □

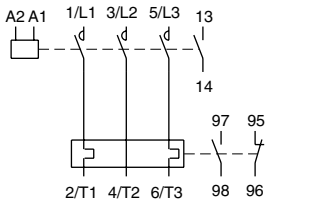

MSO-N10, N11

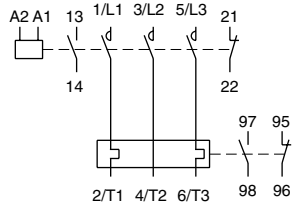

MSO-N12, N20

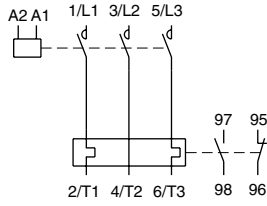

MSO-N18

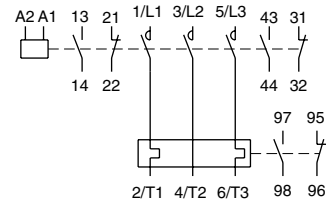

MSO-N21~N35

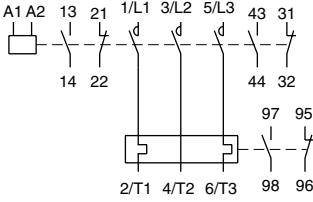

MSO-N50~N150

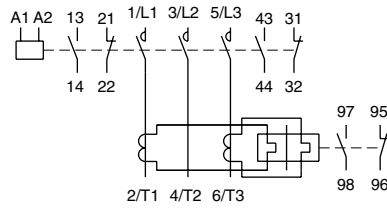

MSO-N180~N400

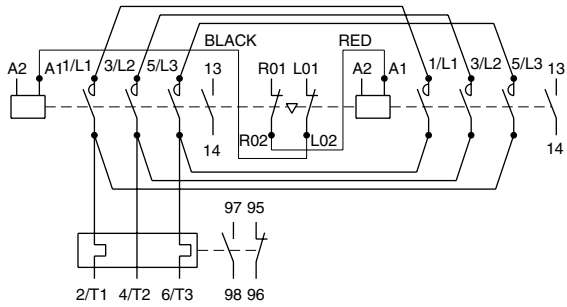

MSO-2xN10, N11

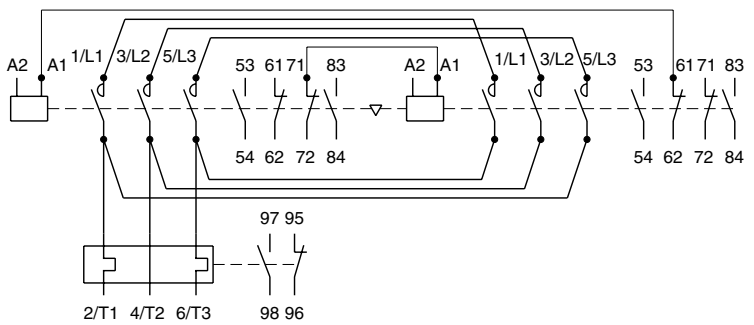

MSO-2xN18

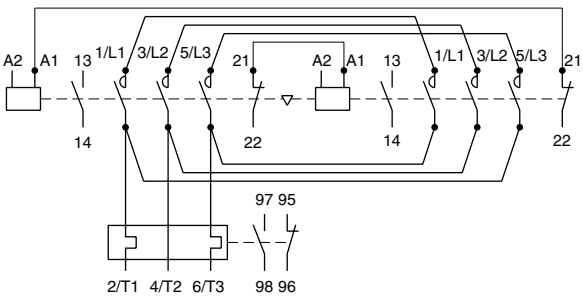

MSO-2xN20

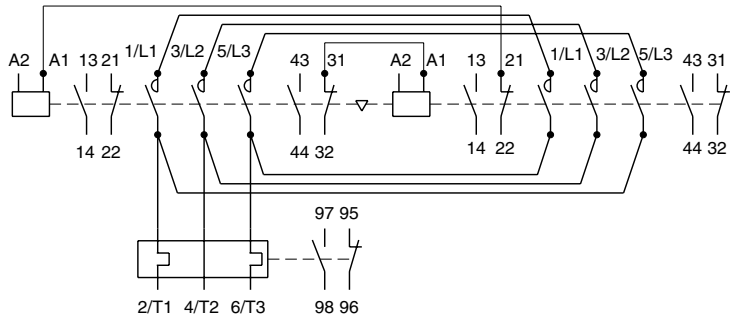

MSO-2xN21~N35

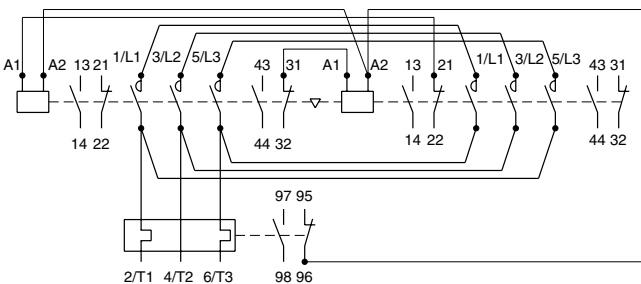

MSO-2xN50~N150

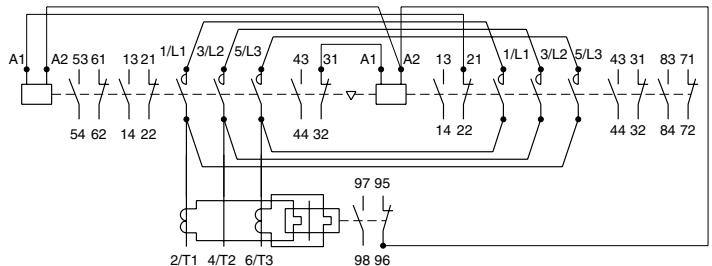

MSO-2xN180~N400

1.9.5 MS-N□

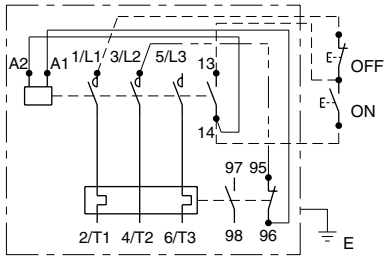

MS-N10, N11

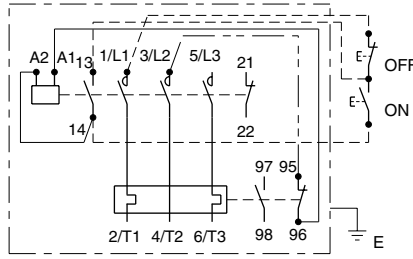

MS-N12, N20

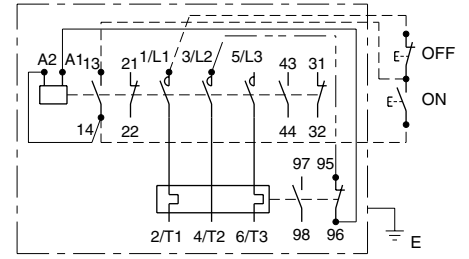

MS-N21, N35

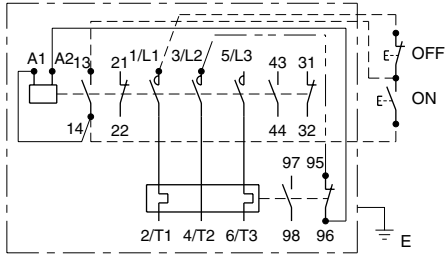

MS-N50~N150

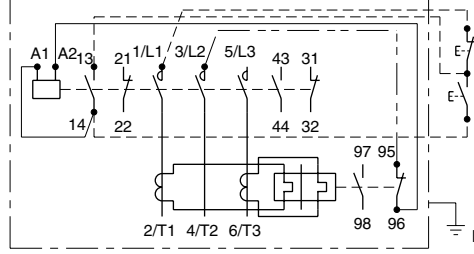

MS-N180~N400

Notes: 1. This shows the state when the same power is used for the main circuit and control circuit. The section shown with a solid line is already wired. The sections shown with a dashed line and a two points of chain line must be wired. (Use the wire enclosed with the product for the two points of chain line section.)

2. If the main circuit and control circuit power differ, do not connect a wire between the dashed line 1/L1-OFF button and the wire between the two points of chain line section 3/L2-TH95. Wire to the OFF button and TH95 terminal from a different control circuit's power supply.

1.9.6 MS-N□PM

common control

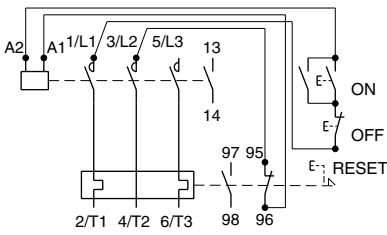

MS-N10, N11PM

common control

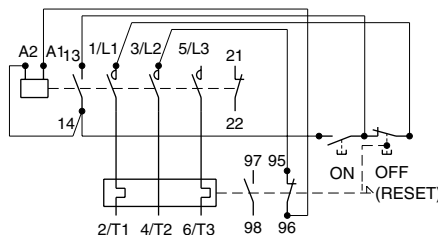

MS-N20PM

separate control

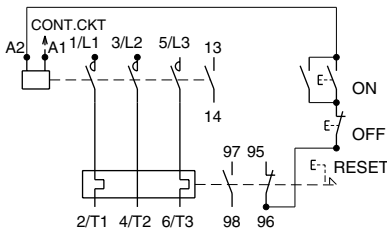

common control

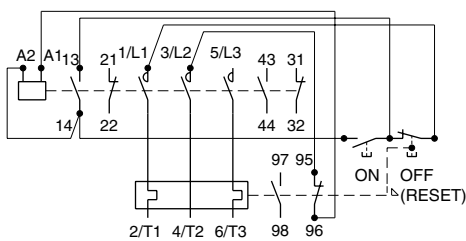

MS-N21~N35PM

separate control

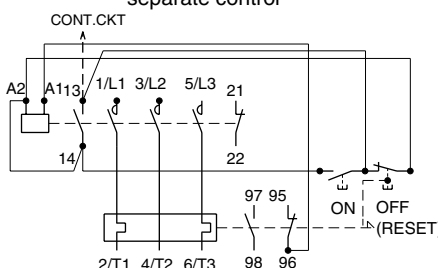

common control

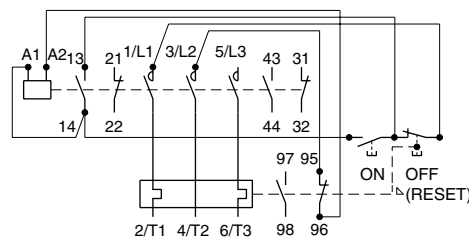

MS-N50~N95PM

separate control

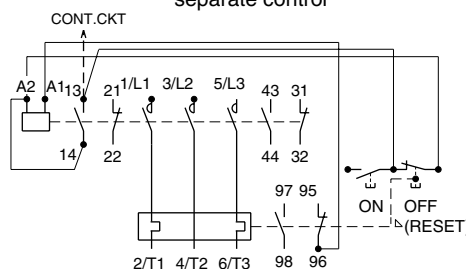

separate control

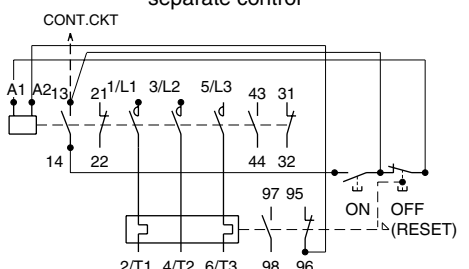

1.10 Outline Dimensions

1.10.1 Outline Dimensions of Non-Reversing Contactors

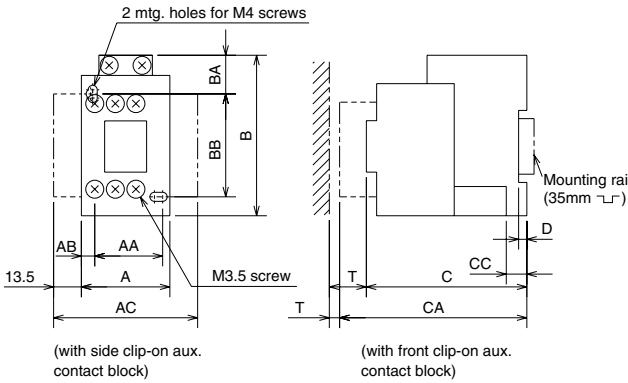

• Dimensions

Type	A	B	C	AA	AB	AC	BB	BA	CC	CA	D	Mass(kg)	T
S-N10(CX),-N11(CX)	43	78	78	35	4.5	70	50	19	10	106	4	0.3	5
S-N12(CX)	53	78	78	40	4.5	—	50	19	10	106	4	0.32	5
S-N18(CX)	43	79	81	30	6	—	60	13	10	109	4	0.33	5
SD-N11(CX)	43	78	110	35	4.5	70	50	19	10	138	4	0.62	5
SD-N12(CX)	53	78	110	40	4.5	—	50	19	10	138	4	0.64	5

Note: Front clip-on and side clip-on aux. contact blocks should not be mounted both.

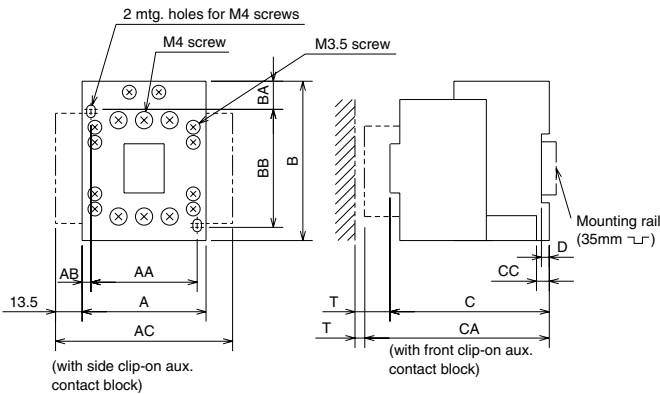

• Dimensions

Type	A	B	C	AA	AB	AC	BB	BA	CC	CA	D	Mass(kg)	T
S-N20(CX),-21(CX)	63	81	81	54	4.5	90	60	14	6.5	109	4	0.4	5
S-N25(CX),-N35(CX)	75	89	91	65	5	102	70	13	6.5	119	4	0.52	5
SD-N21(CX)	63	81	113	54	4.5	90	60	14	6.5	141	4	0.72	5
SD-N35(CX)	75	89	123	65	5	102	70	13	6.5	151	4	0.85	5
SLD-N21	63	81	137	54	4.5	90	60	14	6.5	—	4	0.55	5
SLD-N35	75	89	147	65	5	102	70	13	6.5	—	4	0.67	5

Note: Front clip-on and side clip-on aux. contact blocks should not be mounted both.

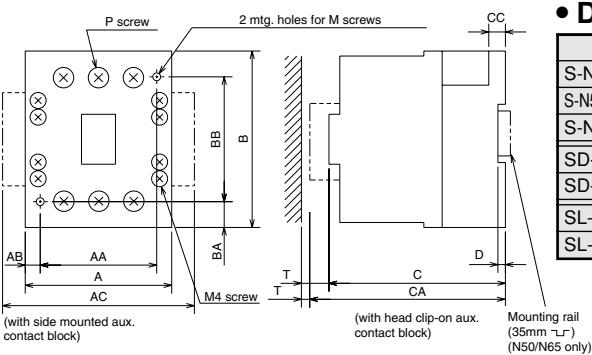

• Dimensions

Type	A	B	C	AA	AB	AC	BB	BA	CC	CA	D	M	P	Mass(kg)	T
S-N50,-N65	88	106	106	70	9	—	75	15.5	10	135	4.5	M4	M6	0.75	10
S-N50CX,-N65CX	88	108	106	70	9	—	75	15.5	10	135	4.5	M4	M6	0.77	10
S-N80,-N95	100	124	127	80	10	128	110	7	12	—	—	M5	M6	1.8	10
SD-N50,-N65	88	107.5	133	70	9	—	75	15.5	10	—	—	M4	M6	2.1	10
SD-N80,-N95	100	134	157	80	10	128	110	7	12	—	—	M5	M6	3.3	10
SL-N50,-N65	88	106	135.5	70	9	—	75	15.5	10	—	—	M4	M6	1.3	10
SL-N80,-N95	100	172	127	80	10	128	110	7	12	—	—	M5	M6	2.1	10

• Dimensions

Type	A	B	C	AA	AB	BB	BA	CC	CA	D	M	P	Mass(kg)	T
S-N125	100	150	137	90	5	125	12.5	1.6	—	—	M4	M8	2.5	10
S-N150	120	160	145	100	10	125	17.5	1.6	—	—	M5	M8	3.2	10
S-N180,-N220	138	204	175	120	9	190	7	1.6	—	—	M6	M10	5.5	10
S-N300,-N400	163	243	195	145	9	225	9	2.3	—	—	M8	M12	9.5	10
S-N600,-N800	290	310	235	250	20	250	30	10.5	—	—	M10	M16	27	10
SD-N125	102	150	162	90	5	125	12.5	1.6	—	—	M4	M8	4.3	30
SD-N150	120	160	169.5	100	10	125	17.5	1.6	—	—	M5	M8	4.3	30
SD-N220	138	204	200.5	120	9	190	7	2.0	—	—	M6	M10	7.5	30
SD-N300,-N400	163	243	221	145	9	225	9	2.3	—	—	M8	M12	13.5	50
SD-N600,-N800	375	310	235	250	20	250	30	10.5	—	—	M10	M16	28	10
SL(D)-N125	100	191	137	90	5	125	12.5	1.6	—	—	M4	M8	3.0	30
SL(D)-N150	120	201	145	100	10	125	17.5	1.6	—	—	M5	M8	3.6	30
SL(D)-N220	138	224	175	120	9	190	7	1.6	—	—	M6	M10	6.0	30
SL(D)-N300,-N400	163	259	195	145	9	225	9	2.3	—	—	M8	M12	10	50
SL(D)-N600,-N800	290	390	235	250	20	250	30	10.5	—	—	M10	M16	27	10

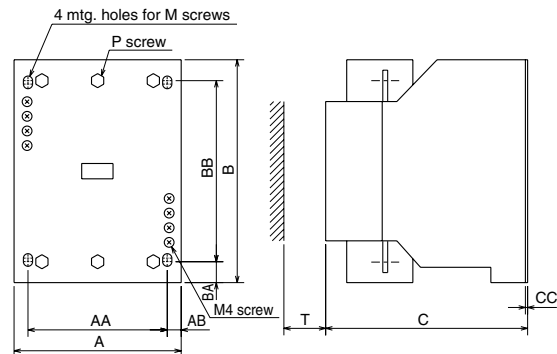

1.10.2 Outline Dimensions of Reversing Contactors

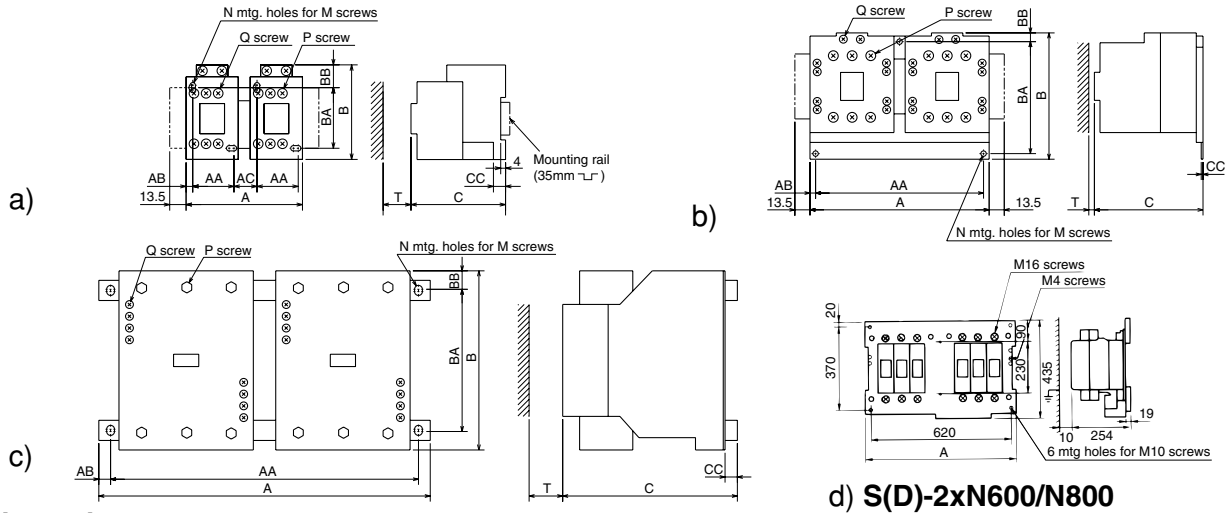

• Dimensions

Type	Fig.	A	B	C	AA	AB	AC	BA	BB	CC	N	M	P	Q	Mass(kg)	T
S-2xN10/N11	a	99	78	78	35	4.5	21	50	19	10	4	M4	M3.5	M3.5	0.64	5
S-2xN18	a	96	79	109	30	3.5	23	60	13	10	4	M4	M4	M3.5	0.75	5
S-2xN20/N21	a	136	81	81	54	4.5	19	60	14	6.5	4	M4	M4	M3.5	0.8	5
S-2xN25/N35	b	160	110	97	150	15	—	100	8	1.6	3	M4	M5	M3.5	1.3	5
S-2xN50/N65	b	216	115	112	204	6	—	100	8	2	3	M5	M6	M4	2.6	10
S-2xN80/N95	b	270	140	137	247	11.5	—	100	32	10	3	M6	M6	M4	4.3	10
S-2xN125	c	276	150	148	255	10.5	—	125	12.5	1.6	4	M6	M8	M4	5.7	30
S-2xN150	c	296	160	156	275	10.5	—	125	17.5	1.6	4	M6	M8	M4	7.2	30
S-2xN180/220	c	370	215	189	340	15	—	190	12.5	1.6	4	M8	M10	M4	12	30
S-2xN300/N400	c	395	250	209	365	15	—	225	12.5	2.3	4	M8	M12	M4	20.5	50
S-2xN600/N800	d	660	—	—	—	—	—	—	—	—	—	—	—	—	54	—
SD-2xN11	a	99	78	110	35	4.5	21	50	19	10	4	M4	M3.5	M3.5	1.3	5
SD-2xN21	b	160	100	119	150	5	—	90	5	2	3	M4	M4	M3.5	1.7	5
SD-2xN35	b	160	113	129	150	5	—	100	8	1.6	3	M4	M5	M3.5	2.0	5
SD-2xN50/N65	b	216	116.5	133	204	6	—	100	8	2	3	M5	M6	M4	4.5	10
SD-2xN80/N95	b	270	140	167	247	11.5	—	100	32	10	3	M6	M6	M4	6.4	10
SD-2xN125	c	276	150	173	255	10.5	—	125	12.5	1.6	4	M6	M8	M4	9.2	30
SD-2xN150	c	296	160	180.5	275	10.5	—	125	17.5	1.6	4	M6	M8	M4	10	30
SD-2xN220	c	370	215	214.5	340	15	—	190	12.5	1.6	4	M8	M10	M4	17	30
SD-2xN300/N400	c	395	250	235	365	15	—	225	12.5	2.3	4	M8	M12	M4	29	50
SD-2xN600/N800	d	800	—	—	—	—	—	—	—	—	—	—	—	—	64	—

Latched Contactors (Reversing)

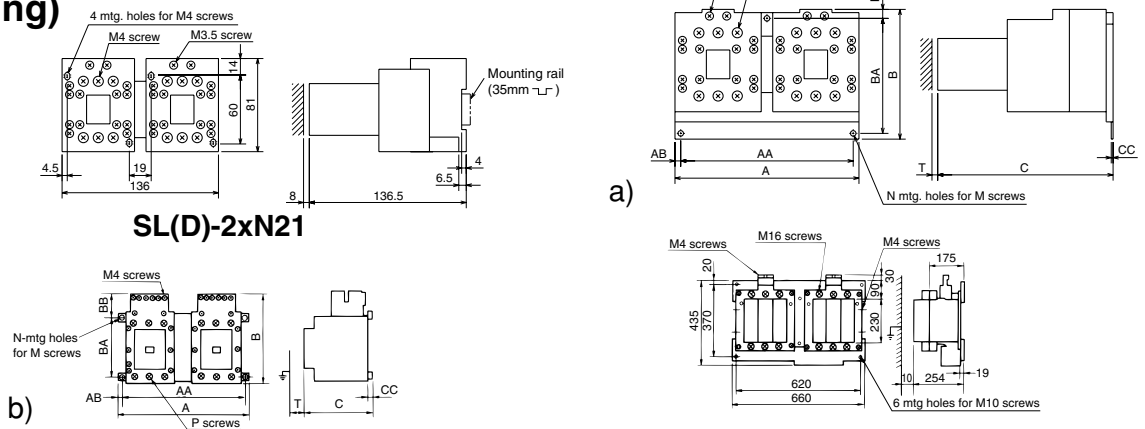

• Dimensions

Type	Fig.	A	B	C	AA	AB	BA(BC)	BB	CC	N	M	P	Q	Mass(kg)	T
SL(D)-2xN35	a	160	113	153	150	5	100	8	1.6	3	M4	M5	M3.5	2.2	5
SL(D)-2xN50/N65	a	216	115	141.5	204	6	100	8	2	3	M5	M6	M4	3.2	10
SL(D)-2xN80/N95	b	270	184	137	247	11.5	100	74	10	3	M6	M6	M4	5.3	10
SL(D)-2xN125	b	276	191	148	255	10.5	125	53.5	11	4	M6	M8	M4	6.7	30
SL(D)-2xN150	b	296	201	156	275	10.5	125	58.5	11	4	M8	M8	M4	8.8	30
SL(D)-2xN220	b	370	230	189	340	15	190	27	14	4	M8	M10	M4	13	30
SL(D)-2xN300/N400	b	395	263	209	365	15	225	25	14	4	M8	M12	M4	21.5	50

1.10.3 Outline Dimensions of Open Type Starters

■ Nonreversing Starters without Enclosures

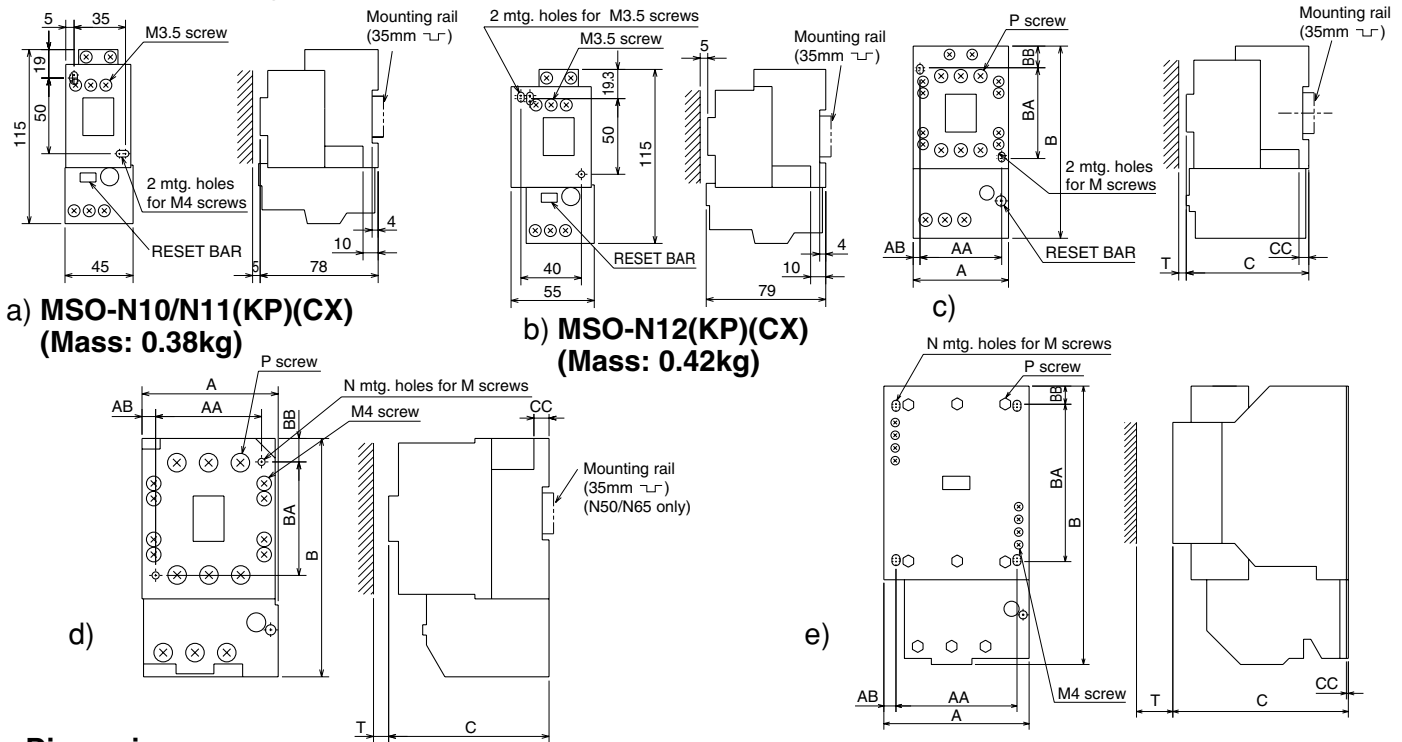

• Dimensions

Type	Fig.	A	B	C	AA	AB	BA	BB	CC	N	M	P ¹	Mass(kg)	T
MSO-N18(CX)(KP)	c	54	122	81	30	7	60	13	10	2	M4	M4(M3.5)	0.5	5
MSO-N20(CX)(KP)	c	63	127	81	54	4.5	60	14	6.5	2	M4	M4(M3.5)	0.6	5
MSO-N21(CX)(KP)	c	63	127	81	54	4.5	60	14	6.5	2	M4	M4(M3.5)	0.6	5
MSO-N25/N35(CX)(KP)	c	75	157	91	65	5	70	13	6.5	2	M4	M5(M3.5)	0.8	5
MSO-N50/N65(KP)	d	90	158	106	70	9	75	16	10	2	M4	M6	2.2	10
MSO-N50/N65(CX)(KP)	d	92	160	106	70	9	75	18	10	2	M4	M6	2.3	10
MSO-N80/N95(KP)	d	100	196	127	80	10	110	7	12	2	M5	M6	3.2	10
MSO-N125(KP)	e	112	239	137	90	14	125	12.5	1.6	4	M4	M8	4.2	30
MSO-N150(KP)	e	120	250	145	100	10	125	17.5	1.6	4	M5	M8	7.7	30
MSO-N180/N220(KP)	e	144	282	180.5	120	12	190	7	1.6	4	M6	M10	7.7	30
MSO-N300/N400(KP)	e	163	358	195	145	9	225	9	2.3	4	M8	M12	12.5	50

Note: 1. Value in parenthesis shows terminal screw of coil and auxiliary contact.

■ Reversing Starters without Enclosures

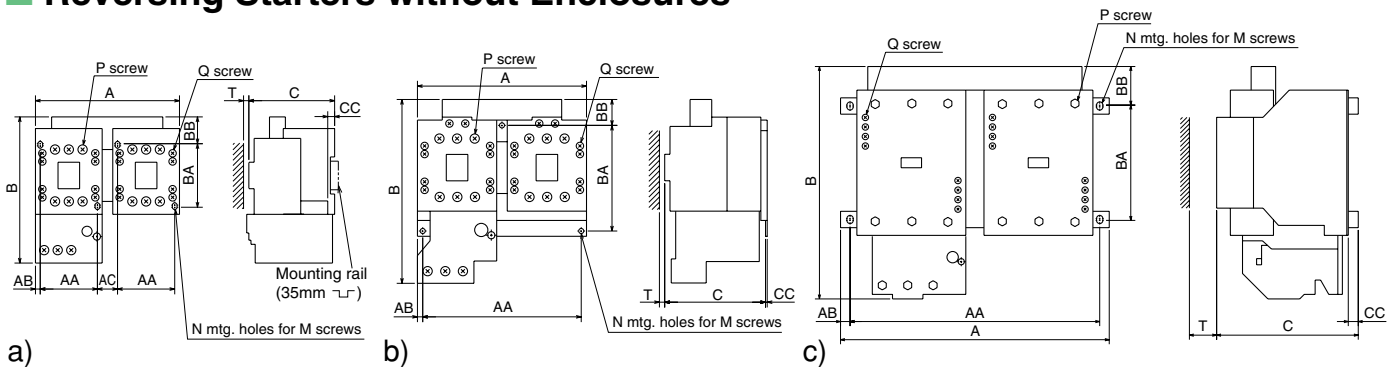

• Dimensions

Type	Fig.	A	B	C	AA	AB	AC	BA	BB	CC	N	M	P	Q	Mass(kg)	T
MSO-2xN10/N11(CX)(KP)	a	99	125	79	35	4.5	21	50	19	10	4	M4	M3.5	M3.5	0.76	5
MSO-2xN18(CX)(KP)	a	97	134	109	30	6.5	23	60	13	10	4	M4	M4	M3.5	0.9	5
MSO-2xN20/N21(CX)(KP)	a	136	138	81	54	4.5	19	60	14	6.5	4	M4	M4	M3.5	1.0	5
MSO-2xN25/N35(CX)(KP)	b	160	159	97	150	5	—	100	8	1.6	3	M4	M5	M3.5	1.3	5
MSO-2xN50/N60(CX)(KP)	b	216	169	112	204	6	—	100	17	2	3	M5	M6	M4	2.9	10
MSO-2xN80/N95(KP)	b	270	213	137	247	11.5	—	100	45.5	10	3	M6	M6	M4	4.6	10
MSO-2xN125(KP)	c	276	251	148	255	10.5	—	125	24.5	11	4	M6	M8	M4	6.6	30
MSO-2xN150(KP)	c	296	276	156	275	10.5	—	125	43.5	11	4	M6	M8	M4	8.5	30
MSO-2xN180/N220(KP)	c	370	304	194.5	340	15	—	190	28.5	14	4	M8	M10	M4	14.5	30
MSO-2xN300/N400(KP)	c	395	392	209	365	15	—	225	42.5	14	4	M8	M12	M4	24.5	50

1.10.4 Outline Dimensions of Enclosed Motor Starters

■ Nonreversing Starters with Enclosures

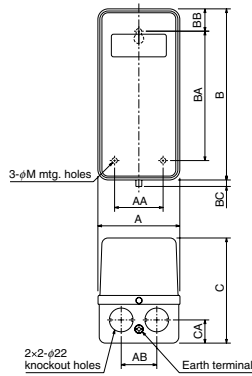

MS-N10(KP)-N21(KP)

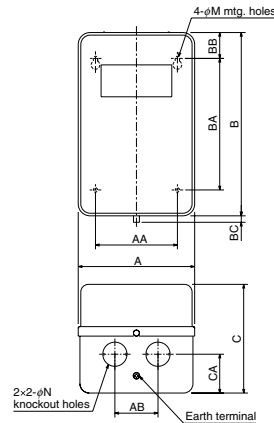

MS-N25(KP)-N400(KP)

• Dimensions

Type	A	AA	AB	B	BA	BB	BC	C	CA	M	N	Mass(kg)
MS-N10/K11(KP)	76	45	33	159	120	21	6	97.5	21.5	4	22	0.8
MS-N12(KP)	76	45	33	159	120	21	6	97.5	21.5	5	22	0.9
MS-N20(KP)/N21(KP)	104	76	50	170	140	15	6	110	30	6	22	1.1
MS-N25(KP)/N35(KP)	135	95	50	225	165	30	6	126	45	6	28	2.0
MS-N50(KP)	160	120	80	270	220	25	12	145	45	6	22 × 35	3.2
MS-N65(KP)	160	120	80	270	220	25	12	145	45	6	22 × 35	3.2
MS-N80/N95(KP)	190	150	100	300	260	20	12	163	67	7	22 × 35	4.0
MS-N125(KP)	230	170	90	384	330	29	12	190	80	9	44 × 50	8.0
MS-N150(KP)	270	200	120	484	400	44	12	209	85	9	44 × 50	12.8
MS-N180/N220(KP)	270	200	120	484	400	44	12	209	85	9	44 × 50	16.2
MS-N300/N400(KP)	440	320	160	590	480	55	12	220	140/90*	11	62 × 78	28

* Left value is for power-supply side, right for load side.

■ Enclosed Type Nonreversing Starters with Pushbuttons

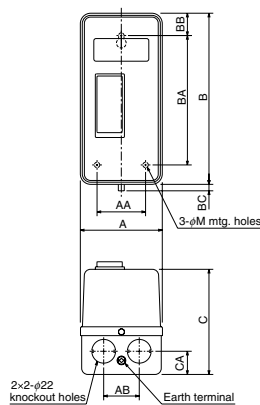

MS-N10PM(KP)-N21PM(KP)

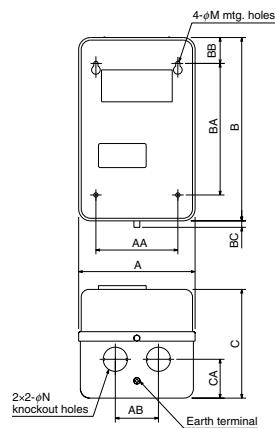

MS-N25PM(KP)-N95PM(KP)

• Dimensions

Type	A	AA	AB	B	BA	BB	BC	C	CA	M	N	Mass(kg)
MS-N10/N11PM(KP)	76	45	33	159	120	21	6	114	22	4	22	0.9
MS-N20PM(KP) MS-N21PM(KP)	104	76	50	170	140	15	6	114	30	6	22	1.3
MS-N25/N35PM(KP)	135	95	50	225	165	30	6	130	45	6	28	2.1
MS-N50/N65PM(KP)	160	120	80	270	220	25	12	149	45	6	22 × 35	3.3
MS-N80/N95PM(KP)	190	150	100	300	260	20	12	167	67	7	22 × 35	4.1